



2025

Siding Collection

Vinyl, Polymer, Composite,
Aluminum Siding & Stone
Veneer, Trim and Accessories



Welcome to the **2025** CertainTeed Siding Collection

Higher Standards

Higher Standards and Greater Rewards are about the many ways



Why CertainTeed4

Choosing the Right Products.....8

2025 Highlights.....10

Info Key14

Shakes & Shingles

Cedar Impressions®
Sawmill Shingles 18

Cedar Impressions®
Perfection Shingles 22

Cedar Impressions® Shapes.....26

Cedar Impressions®
Rough-Split Shakes.....28

Northwoods®
Perfection Shingles, Rough Split
Shakes and Sawmill Shingles..... 32

Composite Siding

RISE® Siding and Trim36

Aluminum Siding

Urban Reserve™38

Stone Veneer

STONEfaçade® 40

Insulated Siding

CedarBoards™/ XL 44

Reinforced Siding

CERTAPlank® 48

Reverse Board & Batten50

Horizontal & Vertical Siding

Board & Batten Vertical Siding..... 52

Monogram®/ XL..... 54

Restoration Classic™ 58

Carolina Beaded™ 62

MainStreet™ 64

American Legend™ 68

Encore™ 70

Greater Rewards

CertainTeed helps you differentiate yourself to grow your business.

➤ This starts with a comprehensive array of exterior products that allow your customers to express their unique personal style. CertainTeed products deliver higher standards in selection, beauty and performance.

In fact, CertainTeed offers the broadest selection of exterior products, styles and colors to achieve a full range of design options. No other company can match CertainTeed's portfolio of products. With all our products we offer freedom of choice for your customers to experiment with style, color and texture... the freedom to be creative, to mix and match and think beyond just four walls. Your customers will appreciate that you are providing them with the products and expertise to achieve their vision - no matter what their vision may be.

For you, higher standards mean focusing our extensive industry experience to help you navigate the challenging construction market. We pledge to support you with educational opportunities, contractor certification, rebate programs and comprehensive marketing tools that empower you with the knowledge and confidence to outpace your competition. Look to CertainTeed as your trusted partner for making a positive and lasting impression on every customer you meet.

Earn greater rewards through more opportunities to grow your business by helping customers discover the finest roofing, siding, and trim that will transform the appearance of their homes.

Moreover, CertainTeed offers the 5-Star Contractor Program, the premier contractor program in the industry. 5-Star contractors are truly treated as partners. CertainTeed offers industry leading training programs, as well as sales, marketing and business-building tools, to provide contractors with the professional credentials necessary to stand out in today's marketplace. Plus, we make it easy for homeowners to find knowledgeable, skilled and trustworthy professionals through our robust "Find a Pro" website tool. No other program is as extensive or more focused on partnering with contractors for success.

At CertainTeed, we understand that our success is tied directly to your success.

Vinyl and Aluminum Soffit / Porch Panel

Invisivent® Triple 3-1/3"	73
Perimeter™ Triple 3-1/3"	73
Beaded	73
Ironmax™	74
Universal	74
Value	75
Aluminum Triple 4"	76
Aluminum Quad 4"	76
Aluminum Accessories.....	77

Trim

Vinyl Carpentry®	78
Restoration Millwork®	80
Finishing Touches	82

Underlayment

CertaWrap™	84
------------------	----

Colors shown throughout this brochure are as accurate as printing methods will permit. Please see product samples before making final selection. Materials of differing gloss level, texture, composition and orientation can look different despite being the same color, it is important to get samples of every product being considered and place them where they will be installed.

On Cover:

Siding: Monogram D5" Dutchlap in Natural Clay and STONEfaçade in Pocono Autumn.

Trim: Vinyl Carpentry®.

Why CertainTeed?

Trust

Professionals agree, CertainTeed still leads the Vinyl and Polymer Siding industry

For the 28th year in a row, builders and contractors named CertainTeed Vinyl Siding Number One in the categories: Brand Familiarity; Brands Used in the Past Two Years and Brands Used Most in the Hanley-Wood Brand Use Study.



CertainTeed offers an industry-leading spectrum of colors including unique darker shades and semi-transparent stained colors for virtually unlimited design possibilities.

Utilizing the newest technology and state-of-the-art formulations, CertainTeed backs their vinyl siding with PermaCOLOR Lifetime Fade Protection.

Warranty

Simply put, if our product fails due to a manufacturing defect, we will stand behind it. To obtain a copy of our complete warranty go to www.certainteed.com

Service

Local Manufacturing

CertainTeed's vinyl and polymer building products are shipped from one of nine manufacturing facilities throughout United States and Canada, ensuring that you are rarely more than 500 miles from a factory location.

Professional Distributors

Our strong network of local distributors enables you to rest easy knowing that you will have complete access to CertainTeed's full line of exterior products.

Experienced Territory Managers

With over 250 territory managers across North America, it is easy to find a CertainTeed representative who can assist you in growing your business.

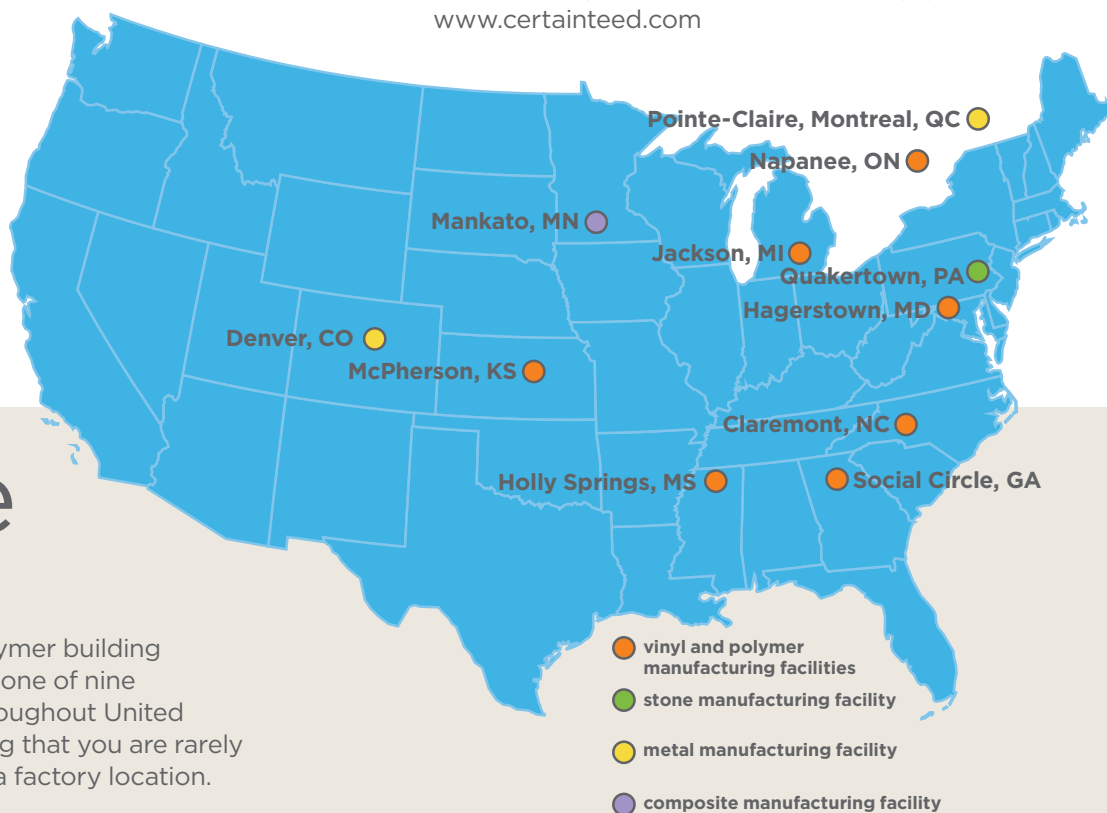

Mobile Training Vehicles



Expert Training and Education

Each year CertainTeed travels across North America putting on over 200 local training programs designed to help you increase your skills, capabilities and profit potential.

Mix & Match

Benefit from the power to mix & match products, styles and colors

CertainTeed's complete selection of exterior product options are tailor-made to take creative advantage of the exciting mix-and-match approach to exterior home design - combining various products, styles and colors to create truly unique exterior designs.

Using combinations of horizontal and vertical siding plus shakes and shingles together makes a bold statement. Adding soffit and trim delivers just the right accent. The collection allows your customers to rely on a single, trusted source for virtually every exterior product they need - and gives you more opportunities to cross-sell.



SABLE BROWN

COLONIAL WHITE

SAVANNAH WICKER

AUTUMN RED



SMOKY GRAY

COLONIAL WHITE

STERLING GRAY

STERLING GRAY

CHARCOAL GRAY

Why CertainTeed?

Color Leadership

Together, siding, trim and roofing color selection has a profound impact on the overall look of a home's exterior. Siding and trim colors cover the exterior walls for curb appeal, but this also extends to the roofline, on what one architect calls a home's "fifth façade."

CertainTeed's color alignment simplifies the task of combining siding and roofing with other facets of the overall design to create a cohesive look. From warm and inviting to cool and fresh, there are color palettes to satisfy every preference. All our products deliver the craftsmanship, durability and virtually maintenance-free performance your customers expect from CertainTeed.

ColorView® offers users the ability to mix and match colors and styles on a wide variety of pre-populated home styles to get design ideas.

ColorView DIY lets users who are short on time begin designing today - upload a project picture and in just a few minutes you can mix and match colors and styles on your own project.

ColorView Pro gives users the opportunity to have a photo of their home professionally masked in just a few days for them to use in ColorView Online.



Start exploring all of CertainTeed's color tools now at colorview.certainteed.com



ColorCoach™ is a web-based tool that helps provide some basic education on color theory and helps provide some recommended color combinations for the consumer audience. It also helps contractors and builders recommend CertainTeed roofing, siding, and trim color combinations that look great together.

Colors shown throughout this brochure are as accurate as printing methods will permit. Please see product samples before making final selection. Materials of differing gloss level, texture, composition and orientation can look different despite being the same color, it is important to get samples of every product being considered and place them where they will be installed.

Innovation

TrueTexture™

CertainTeed was the first to produce siding utilizing a direct transfer system from real cedar boards, shingles and shakes to create natural TrueTexture finishes. The look of true wood craftsmanship can be created when combined with CertainTeed's Vinyl Carpentry® and Restoration Millwork®.

Installation Features

Many engineering innovations including SureStop™, EasyMeasure™, PanelThermometer™, HammerTapper™ and StudFinder™ making CertainTeed Siding the industry leader.

Cedar Impressions patented **PanelThermometer™** and temperature lines are designed to ensure precise installation.



SureStop™
Recessed nailing area.

EasyMeasure™



HammerTapper™
Enables lateral adjustment for easier siding panel installation.

STONEfaçade

Patented technology

Fully-integrated rainscreen, and a fastening flange that is designed to provide ease of installation.

Fully-integrated rainscreen

A 3/8" steel insert embedded into each panel allows top-to-bottom drainage that protects walls from moisture build-up, and reduces the potential for moisture-related issues.

Beveled perimeter

Improves overall fit and finish for an uninterrupted appearance along the length of the wall.



STUDfinder™

Designed to help ensure a safe, precise installation for maximum siding performance.



Choosing the right products for your project.

Curb Appeal™ That Lasts

CertainTeed offers an industry-leading selection of low-maintenance products that create beautiful, timeless looks that last.

Authentic from the curb or close up

From historic to modern to timeless, each project has its own unique design challenges. CertainTeed's wide variety of styles and textures empower you to select the product that will deliver the architectural accuracy and beauty required to meet every project's needs.



Industry leading color palette

CertainTeed's color palette simplifies the task of combining siding and roofing with other facets of the overall design to create a cohesive look. From warm and inviting to cool and fresh, there are color palettes to satisfy every preference. Backed by PermaColor™ Lifetime Fade Protection, our products deliver the virtually maintenance-free performance your customers expect.



Details create the personality

The personality of a home is reflected in the unique details of the project. CertainTeed offers a complete selection of virtually maintenance-free accent and decorative trim accessories designed to complement any project.





A modern look that provides a unique touch to any exterior

Urban Reserve™ comes in versatile colors and textures that bring style and sophistication to any design. Combine with other materials and finishes to highlight a home's focal point or use it all over for a fresh and striking look. Choose from 8 fade-resistant solid colors.



The timeless look of stone

Nothing says “Welcome home” like the warm and inviting look of stone. Take your home's exterior to a new level with CertainTeed STONEfaçade, a manufactured architectural stone veneer that delivers the beauty and craftsmanship of natural stone in an affordable, durable, and easy-to-install panelized system.



Perform. Protect. Preserve.

RISE Siding and Trim products are designed for demanding jobs. Quality synthetic fibers such as polyester, nylon, and fiberglass are core ingredients that result in affordable, durable, and long-lasting siding and trim options. These fibers come from post-consumer and post-industrial recycle and waste streams making RISE a forward-looking alternative to cement, and wood-based products.

2025 Highlights

New Product and Color Releases



RISE[®] SIDING & TRIM



WOODGRAIN

SMOOTH

All products available in both woodgrain and true smooth finishes.

Composite Siding

Look/Feel of Wood: You can cut, install and handle RISE siding and trim like traditional wood because RISE mimics natural wood's simplicity and flexibility, but without the associated cost and maintenance. No special tools needed.

Page 36



Ground Contact & Moisture Resistance: RISE products withstand heavy rain and snow while defying freeze/thaw damage and resisting rot. RISE siding and trim products are also the only hard siding products on the market that allow for incidental ground contact.

Easy to Handle: With less breakage and no special tools required, you can save time and reduce jobsite waste. RISE is also the only exterior siding product available in 13' 4" (160") lengths, making it the perfect length for 16" on center stud spacing.

94% Recycle Content: RISE products are created with 94% recycled materials. By reclaiming the high performance synthetic fibers and polymers, we were able to engineer a durable siding solution that reduces the need to landfill these materials.

30-Year Warranty: RISE products are backed by a 30-year substrate limited warranty.

RISE siding and trim is available in primed or pre-painted finishes. Product sizes and pre-finish color availability varies by region.

2025 Highlights

New Product and Color Releases

Urban Reserve™ Aluminum Siding



Transform any exterior with a contemporary accent or shield an entire home with lasting beauty. Urban Reserve offers unlimited possibilities installed vertically or horizontally. With premium strength and performance, enjoy reliable, low-maintenance metal siding and soffit in any climate.

Page 38

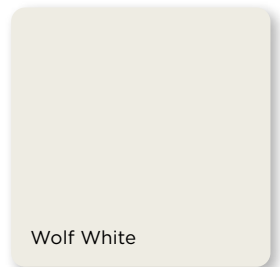
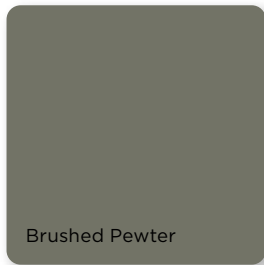
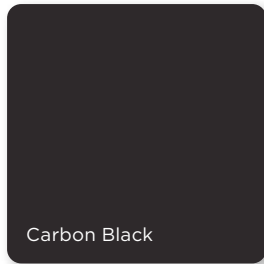
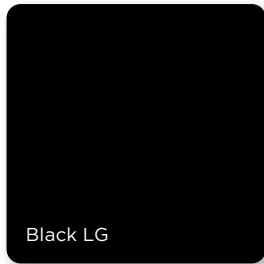
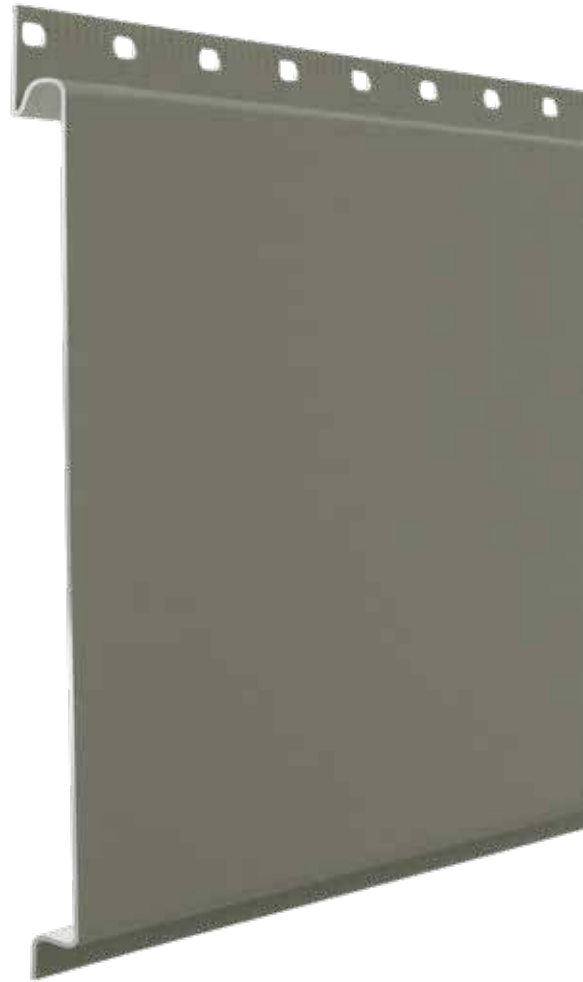

Urban Reserve Panel in Brushed Pewter.

STONEfaçade™



Coastal Storm has been added to the STONEfaçade line alongside a new matching accessory color, Charcoal.

Page 40



Coastal Storm

CedarBoards™



Insulated Siding

Herringbone gets added to Double 6" Clapboard and Single 7" Clapboard. Single 12" Board & Batten inherits Pacific Blue, Flagstone and Charcoal Gray.

Page 22

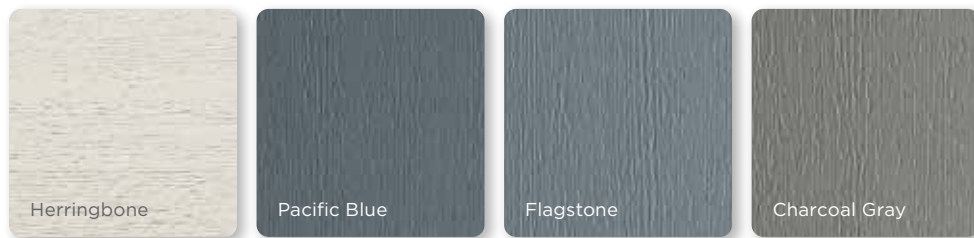

Herringbone

Pacific Blue

Flagstone

Charcoal Gray



Graystone



MainStreet™

Graystone gets added to Double 4" Clapboard, Double 5" Clapboard, Double 4" Dutchlap and Double 5" Dutchlap.

Page 64

Cedar Impressions®



Graystone and Sparrow get added to Cedar Impressions Double 7" Straight Edge Perfection, Triple 5" & Double 7" Staggered. Sparrow only gets added to Cedar Impressions Double 7" Rough-Split.

Page 18, 22, 28



Graystone

Sparrow

Restoration Classic™



Wedgewood Blue, Graystone and Weathered Wood get added to Double 4" Clapboard and Double 4-1/2" Dutchlap.

Page 58



Wedgewood Blue

Weathered Wood

Graystone



Icon Guide

Below you will find an explanation of each icon used for easy reference to identify and compare the many product features, benefits and specifications of the siding products offered by CertainTeed.

Aesthetics



Colors:

Shows the number of different colors available within each product line. The CertainTeed Siding Collection features solid colors that replicate the look of freshly painted cedar and variegated blends which provide the appearance of semi-transparent stained finish.



Extended Lengths:

Indicates products that are available in extended lengths, including 16', 20' and 25'. Longer length siding significantly reduces the number of seams when panels overlap horizontally, increasing the overall aesthetics of the wall.



Panel Projection:

Identifies the full depth of a siding panel as measured from the back of the panel to the tip of the front of the panel. Deeper panel projections add rigidity to siding products while providing wider shadow lines that enhance aesthetics. This measurement is also used for proper sizing of accessories necessary to install the siding.



Profiles:

Lists the number of different profiles available within each product line. A profile is the contour or outline of a panel as viewed from the side or end. Product profiles, such as clapboard and dutchlap, are designed to mimic the different architectural styles of wood or stone cladding products.



Texture:

Indicates available textures within each product line. Whether you are seeking the smooth appearance of milled cedar, or one of the many TrueTexture™ woodgrains molded from real cedar boards, CertainTeed offers a wide array of architecturally authentic product textures to choose from.

Installation



Fastener Indicator:

CertainTeed is the only siding engineered to include an integral fastener placement guide on each panel. The Patented STUDfinder™ Installation System and Cedar Impressions® fastener indicators are designed to help ensure a safe, precise installation for maximum siding performance.



Lock:

Designates the panel lock design of the product. CertainTeed Siding Products feature proprietary locking designs created to optimize the alignment and installation for each specific product. The special features of CertiLock™ and DuraLock® ensure that every siding panel goes on the wall straight and secure.

Performance



Drainability / Moisture Resistance:

Product technology eliminates the common problem of moisture accumulation in wall cavities through the use of innovative materials, rainscreens, weep holes or open designs.



Fade Protection:

CertainTeed offers an industry-leading spectrum of colors including unique, darker shades and semi-transparent stained blends for virtually unlimited design possibilities. Utilizing a unique pigment chemistry, CertainTeed guarantees Lifetime Fade Protection on our vinyl siding.



Fastening Hem Design:

Identifies the type of fastening hem design on a cladding product. Rollovers and / or reinforcing ribs are used to stiffen the nail hem of a siding panel, giving it a straighter appearance on the wall while contributing to the wind load resistance of the product.



Flame Spread Rating:

Indicates products that are Class A Flame Spread Classified, meaning that the material is highly resistant to fire and does not spread flames quickly and/or is self-extinguishing.



Low Maintenance:

Unlike other cladding products that require regular repainting, recaulking, tuck-pointing, and sealing to maintain their aesthetics, CertainTeed cladding products can be kept beautiful using a soft bristle brush and a bucket of soapy water.

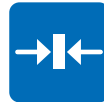

Panel Thickness:

Defines the average thickness or gauge of a siding panel which is an important element of siding quality. Thicker panels look straighter on the wall, are more durable, and hold up against impacts and high winds. CertainTeed siding products are regularly audited by Architectural Testing, Inc. to ensure they meet or exceed ASTM standards for vinyl siding.



Warranty:

CertainTeed shakes, shingles, insulated, horizontal, soffit and vertical products are covered by a Lifetime Limited Warranty.



Wind Load:

This is the rating for the maximum wind pressure that a siding product can withstand. All CertainTeed Siding products* are rigorously tested by Intertek Group plc. to meet or exceed ASTM standards for resistance to negative wind load pressures.

*Products adhere to ASTM D3679, D7793, D7254 standards for capable wind speed ratings based on standard wind load design pressure ratings. For most current ratings, please reference www.certainteed.com.

Colors shown throughout this brochure are as accurate as printing methods will permit. Please see product samples before making final selection. Materials of differing gloss level, texture, composition and orientation can look different despite being the same color, it is important to get samples of every product being considered and place them where they will be installed.

Over 30 YEARS of Impressive Innovations

Generation 2

Introduced multiple new features, including:

- TrueTexture™ realistic wood grain look from real wood cedar shingles
- PanelThermometer™ to indicate the correct panel temperature for precise installation
- Texture added to the butt section of panel
- Hangers and locks were increased to allow for better expansion and contraction
- Improved function of the side tabs for locking
- More styles: Half-Rounds, Triple 5", Rough-Split Shakes in Double 7" and 9"
- Multiple darker colors
- Accessories – outside corners, inside corners, bay corners



1992 – 2003

2004 – 2015

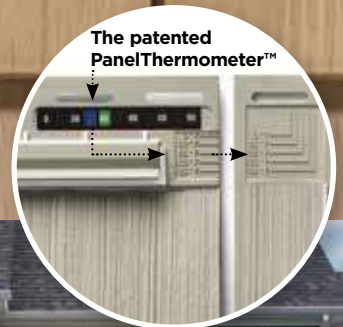
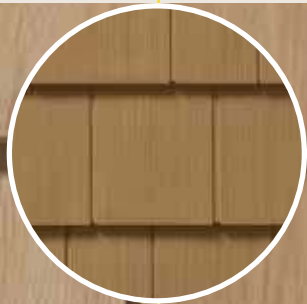

Generation 1

- National launch in 1992
- Double 7" Perfection Shingle, available in 4 colors
- Initially produced as a vacuum-formed product
- First injection molded, vertical woodgrain product for precise duplication of real wood texture



Cedar Impressions®

Polymer Shake & Shingle Siding



Offset corner



HammerTapper™



Continuous nail hem with tape measure



Scallop



Half-Cove

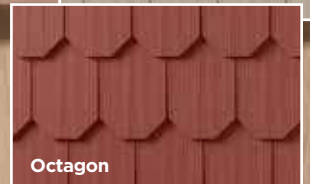

Octagon

2016 - current

Generation 3

- Introduced Triple 5" Sawmill Shingles
 - Also introduced Individual 5" Sawmill Shingles and Single 7" Perfection Shingles featuring Ageless Cedar™ color technology color blended throughout the shingle
 - Created offset corner accessories for a more natural installation
 - Launch a refined Double 7" panel
 - Development of new accent shapes: Scallop, Half-Cove and Octagon
 - Introduced solid colors into the Single 7" panel
- Added the following Engineering Enhancements:
- HammerTapper™ - allows easier positioning of the panel - tap to left and tap to right
 - More natural-looking tapered shingle gaps
 - Continuous nail hem (installation friendly - makes it impossible to miss a tab)
 - Nail stop - indentation in nail hem area to prevent driving nails too tight
 - Tape measure on continuous nail hem to help make proper cuts easier

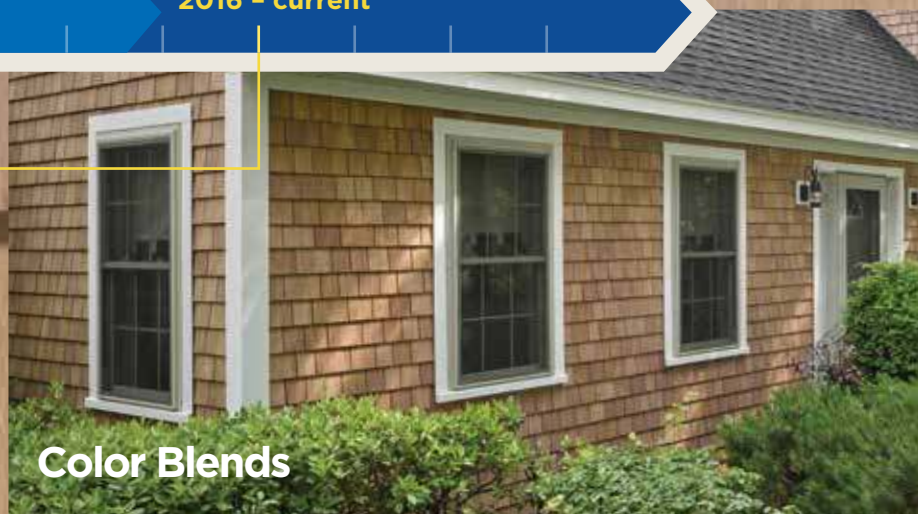

Color Blends

Natural Blend*

Driftwood Blend*

Cedar Blend*

Rustic Blend*



* Balanced Mix - premium colors

Cedar Impressions®

Sawmill Shingles

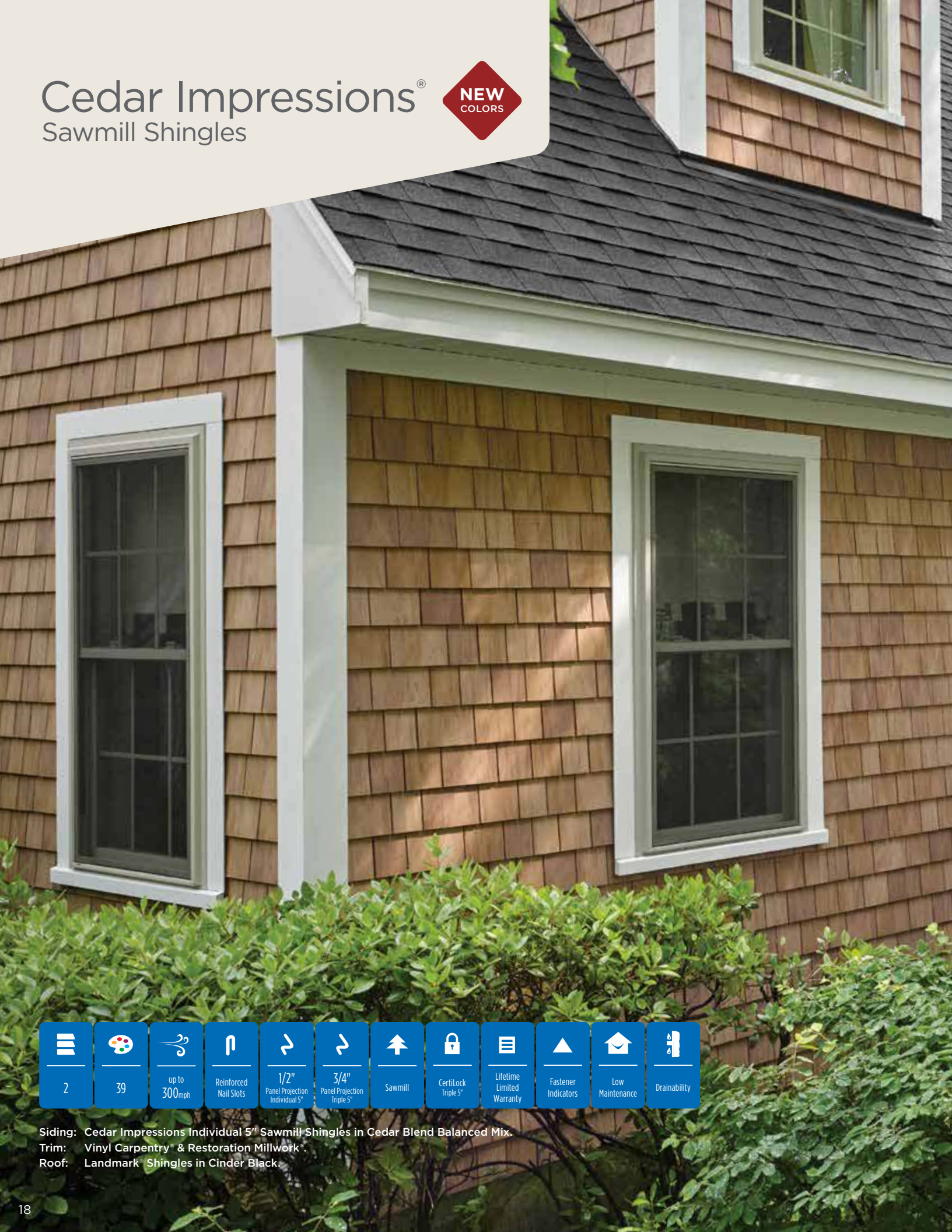

- 2
- 39
- up to 300mph
- Reinforced Nail Slots
- 1/2" Panel Projection Individual 5"
- 3/4" Panel Projection Triple 5"
- Sawmill
- CertiLock Triple 5"
- Lifetime Limited Warranty
- Fastener Indicators
- Low Maintenance
- Drainability

Siding: Cedar Impressions Individual 5" Sawmill Shingles in Cedar Blend Balanced Mix.
Trim: Vinyl Carpentry® & Restoration Millwork®.
Roof: Landmark® Shingles in Cinder Black.



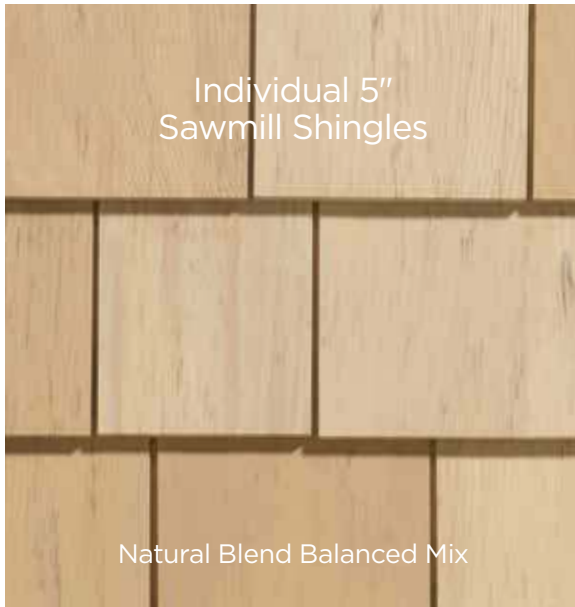

Individual 5"
Sawmill Shingles

Natural Blend Balanced Mix

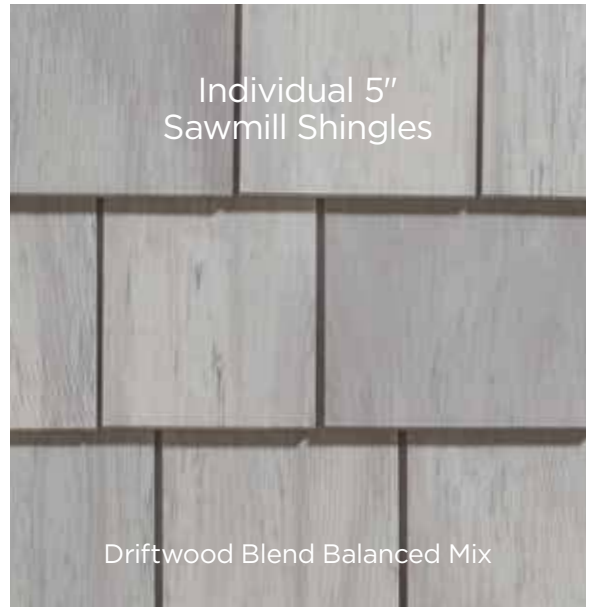

Individual 5"
Sawmill Shingles

Driftwood Blend Balanced Mix



Individual 5"
Sawmill Shingles

Cedar Blend Balanced Mix



Individual 5"
Sawmill Shingles

Rustic Blend Balanced Mix

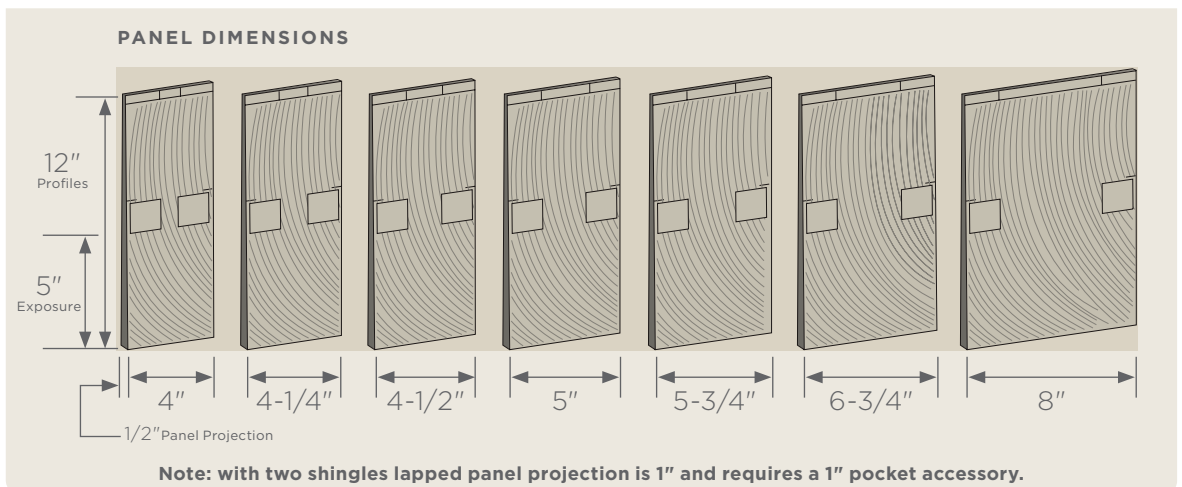

Recommended Trim

CertainTeed recommends the use of Restoration Millwork PVC trim for the most authentic look of genuine cedar. If you choose to use CertainTeed vinyl accessories, the following solid colors are the best comparable options:

- Natural Blend = Buckskin
- Cedar Blend = Cedar Blend Solid
- Driftwood Blend = Granite Gray or Charcoal Gray
- Rustic Blend = Sable Brown

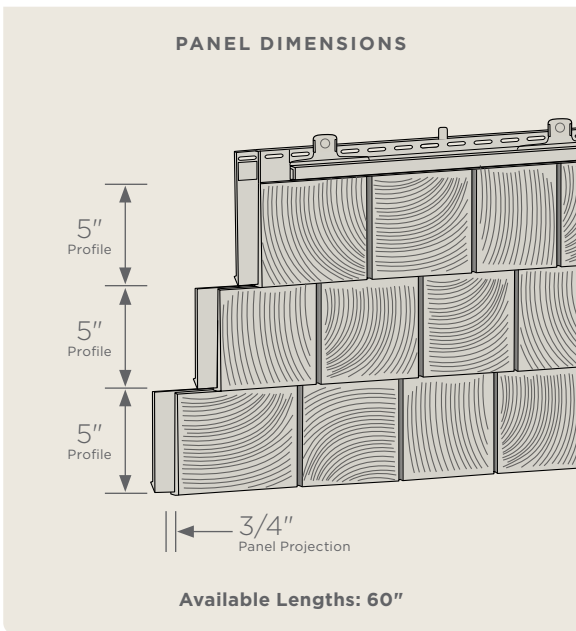

	I5 Sawmill Shingles	T5 Sawmill Shingles	
Natural Blend - Light**	●		
Natural Blend - Medium**	●		
Natural Blend - Dark**	●		
Driftwood Blend - Light**	●		
Driftwood Blend - Medium**	●		
Driftwood Blend - Dark**	●		
Cedar Blend - Light**	●		
Cedar Blend - Medium**	●		
Cedar Blend - Dark**	●		
Rustic Blend - Light**	●		
Rustic Blend - Medium**	●		
Rustic Blend - Dark**	●		
Brownstone		●	
Autumn Red		●	
Slate		●	
Espresso		●	
Sable Brown		●	
Sparrow		★	
Hearthstone		●	
Spruce		●	
Forest		●	
Midnight Blue		●	
Pacific Blue		●	
Wedgewood Blue		●	
Flagstone		●	
Charcoal Gray		●	
Castle Stone		●	
Granite Gray		●	
Graystone		★	
Sterling Gray	●	●	
Seagrass	●	●	
Cypress		●	
Herringbone		●	
Desert Tan		●	
Weathered Wood		●	
Natural Clay	●	●	
Savannah Wicker	●	●	
Heritage Cream		●	
Colonial White	●	●	

NEW
COLOR













NEW
COLOR

**Premium Colors

Cedar Impressions®

Perfection Shingles



-  3
-  38
-  up to 200mph
-  Reinforced Nail Slots
-  3/4" Panel Projection
-  Perfection
-  Molded Perimeter Lock
-  CertiLock Continuous Hanger
-  Lifetime Limited Warranty
-  Fastener Indicators
-  Low Maintenance
-  Drainability

Siding: Cedar Impressions Double 7" Straight Edge Perfection Shingles in Seagrass.
Trim: Vinyl Carpentry® & Restoration Millwork®.
Roof: Highland Slate in Fieldstone.





Double 7"
Straight Edge
Perfection Shingles

Spruce



Double 7"
Staggered
Perfection Shingles

Pacific Blue



Single 7"
Perfection Shingles

Driftwood Blend

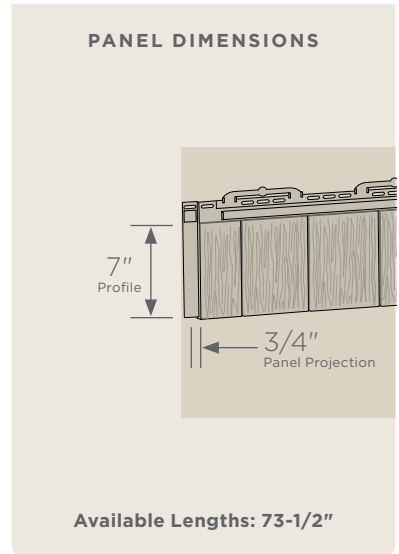
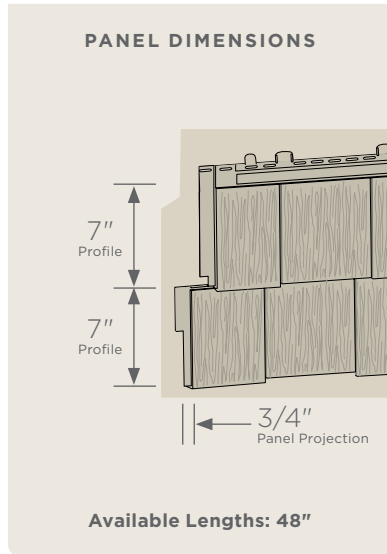
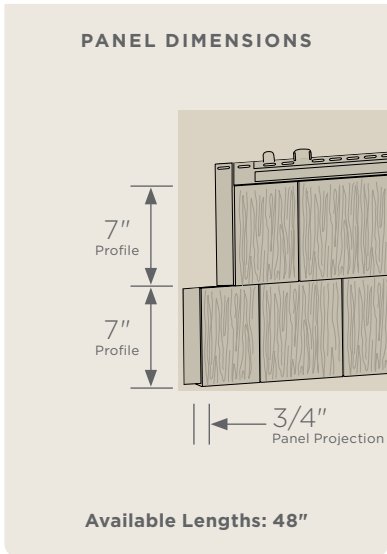

Reinforced
Nail Slots



Fastener
Indicators



Molded
Perimeter
Lock



Perfection



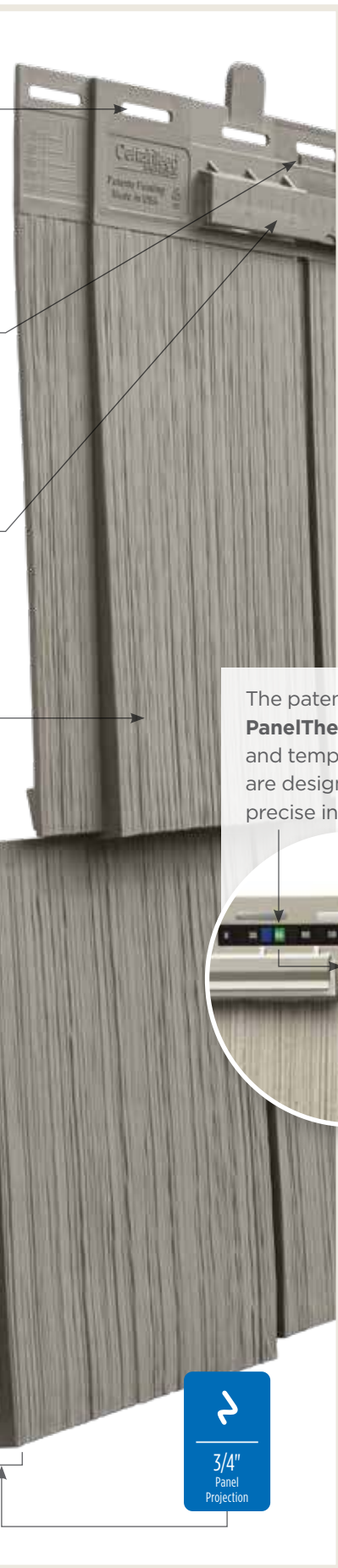

SureStop™
Recessed nailing area

HammerTapper™
Assist pads

EasyMeasure™
Tape Measure

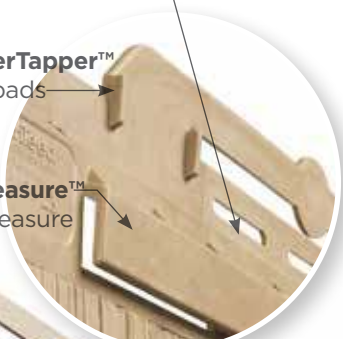

The patented **PanelThermometer™** and temperature lines are designed to ensure precise installation.



3/4"
Panel
Projection

3/4"
Panel
Projection

CertiLock
Continuous
Hanger

Perfection













	D7 Straight Edge Perfection Shingles	D7 Staggered Perfection Shingles	S7 Straight Edge Perfection Shingles
▲ Consistent variegated color throughout the panel.			
Natural Blend**			▲
Driftwood Blend**			▲
Cedar Blend**			▲
Rustic Blend**			▲
Brownstone	●		
Melrose	●		
Autumn Red	●	●	
Mountain Cedar		●	
Tuxedo	●		
Slate	●		
Espresso	●		
Sable Brown	●	●	●
NEW COLOR Sparrow	★	★	
Hearthstone	●	●	●
Spruce	●	●	
Forest	●	●	
Midnight Blue	●		
Deep Mineral	●		
Pacific Blue	●	●	●
Wedgewood Blue	●		
Flagstone	●	●	●
Smoky Gray	●		
Charcoal Gray	●	●	●
Castle Stone	●		
Granite Gray	●	●	●
NEW COLOR Graystone	★	★	
Sterling Gray	●	●	●
Bermuda Blue	●		
Seagrass	●	●	●
Cypress	●	●	●
Herringbone	●	●	
Desert Tan	●	●	
Weathered Wood	●		
Natural Clay	●	●	●
Savannah Wicker	●	●	●
Heritage Cream	●	●	
Snow	●		
Colonial White	●	●	●

★ New Color
**Premium Colors

Cedar Impressions®

Perfection Shapes



- 
3
- 
8
- 
up to
200_{mph}
- 
Reinforced
Nail Slots
- 
3/4"
Panel
Projection
- 
Perfection
- 
Molded
Perimeter
Lock
- 
CertiLock
Continuous
Hanger
- 
Lifetime
Limited
Warranty
- 
Fastener
Indicators
- 
Low
Maintenance
- 
Drainability

Siding: Cedar Impressions Double 7" Straight Edge Perfection Shingles in Charcoal Gray and Cedar Impressions Single 6-1/3" Perfection Octagon Shapes in Charcoal Gray.
Trim: Vinyl Carpentry® & Restoration Millwork®.

	S6 ^{1/3} Perfection Scallops	S6 ^{1/3} Perfection Octagon	S6 ^{1/3} Perfection Half Cove	
Autumn Red	●	●		
Pacific Blue	●	●	●	
Charcoal Gray	●	●		
Sterling Gray	●	●	●	
Cypress	●			
Natural Clay	●	●	●	
Savannah Wicker	●			
Colonial White	●	●	●	

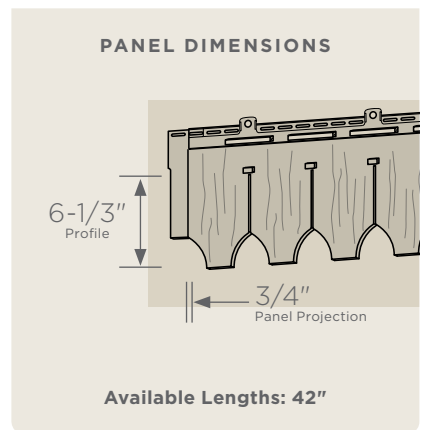
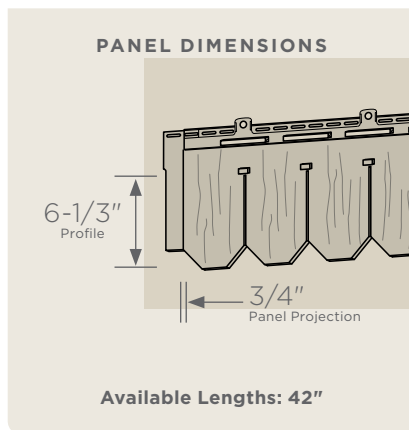
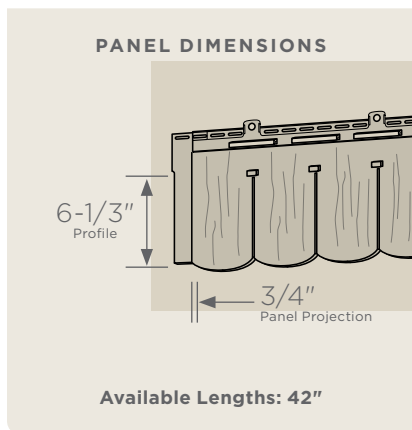
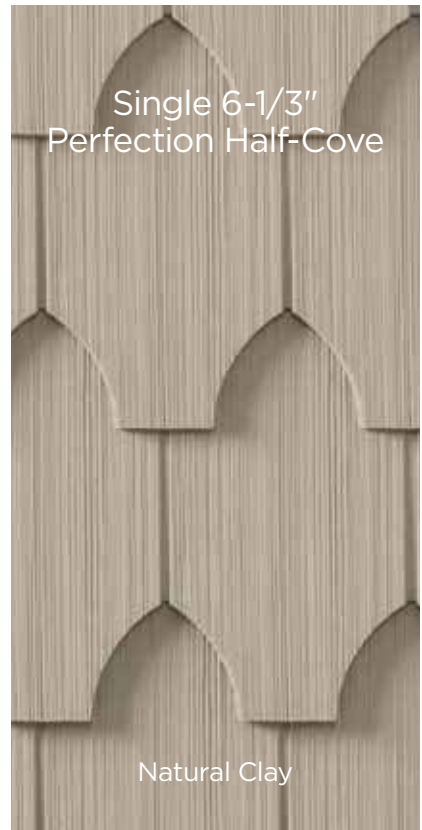

Cedar Impressions®

Rough-Split Shakes

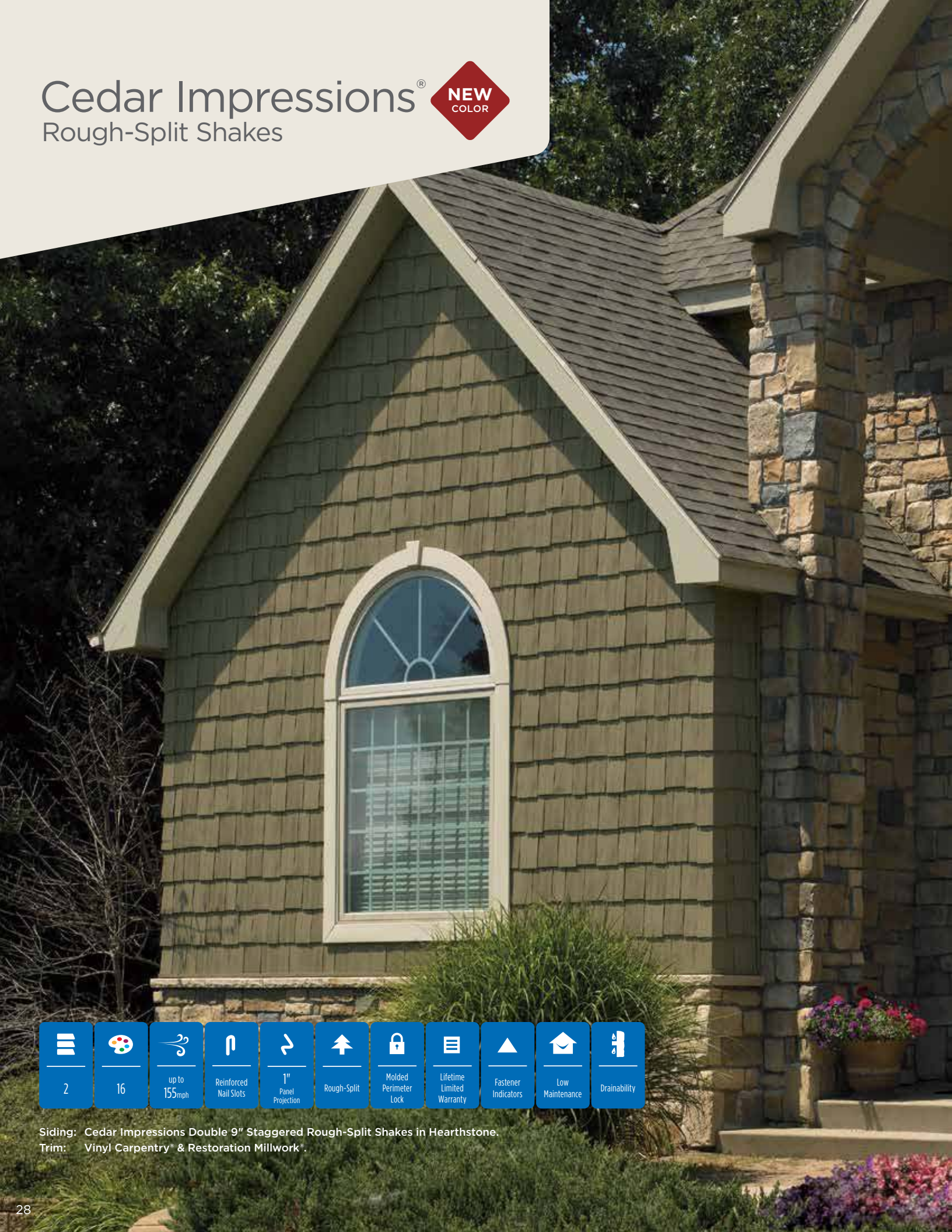

- 
2
- 
16
- 
up to 155mph
- 
Reinforced Nail Slots
- 
1" Panel Projection
- 
Rough-Split
- 
Molded Perimeter Lock
- 
Lifetime Limited Warranty
- 
Fastener Indicators
- 
Low Maintenance
- 
Drainability

Siding: Cedar Impressions Double 9" Staggered Rough-Split Shakes in Hearthstone.
Trim: Vinyl Carpentry® & Restoration Millwork®.





Double 7"
Straight Edge
Rough-Split Shakes



Sable Brown

Double 9"
Staggered Rough-Split Shakes

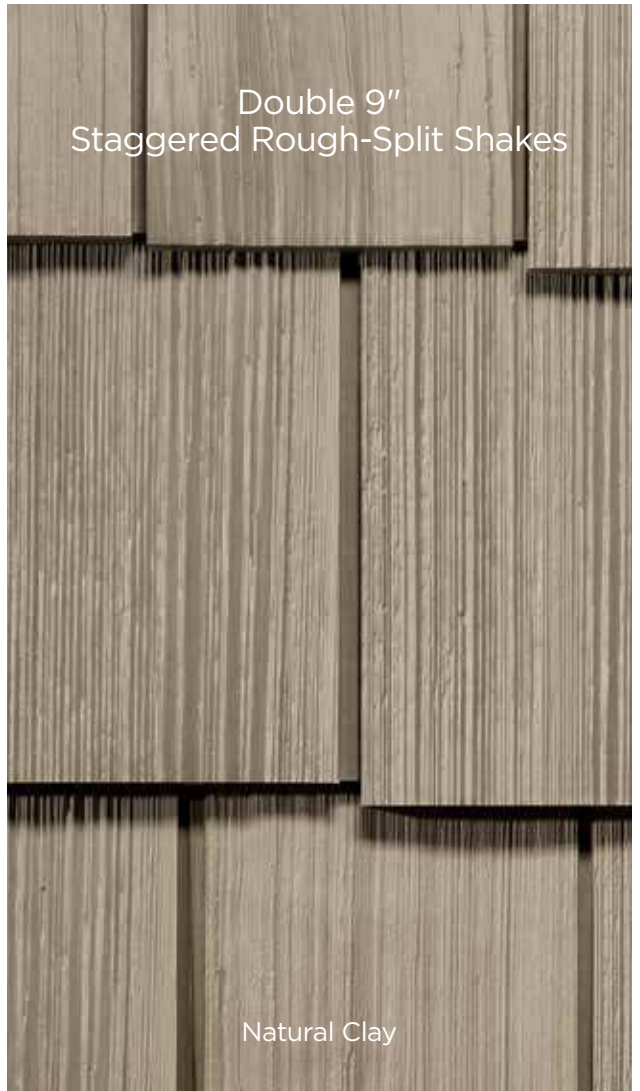

Natural Clay

PANEL DIMENSIONS

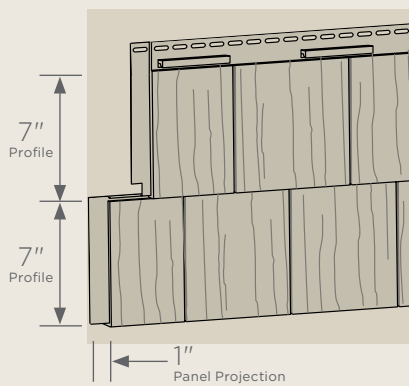

Available Lengths: 57"

PANEL DIMENSIONS

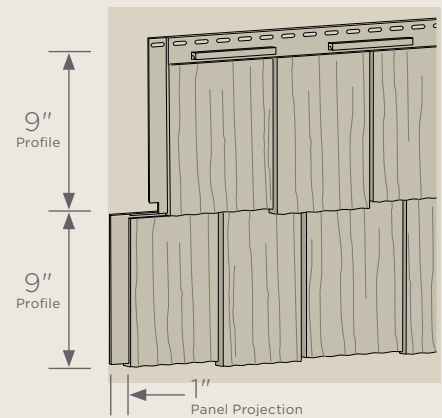

Available Lengths: 57"



The patented **PanelThermometer™** and temperature lines are designed to ensure precise installation.



	D7 Straight Edge Rough-Split Shakes	D9 Staggered Rough-Split Shakes	
Autumn Red	●	●	
Mountain Cedar	●	●	
Sable Brown	●	●	
NEW Sparrow	★		
Hearthstone	●	●	
Spruce	●	●	
Forest	●	●	
Pacific Blue	●	●	
Flagstone	●	●	
Charcoal Gray	●	●	
Granite Gray	●	●	
Sterling Gray	●	●	
Natural Clay	●	●	
Savannah Wicker	●	●	
Buckskin	●	●	
Colonial White	●	●	

★ New Color

Mitered Outside Corner Posts



D7" Rough-Split



D9" Rough-Split

Northwoods®

Perfection Shingles, Rough-Split Shakes & Sawmill Shingles



3	20	up to 180mph	Standard Nail Hem	3/4" Panel Projection Perfection & Sawmill	1" Panel Projection Rough-Split	Perfection, Sawmill, Rough-Split	Lifetime Limited Warranty	Class A Flame Spread	Low Maintenance	Drainability

Siding: Northwoods Single 7" Straight Edge Rough-Split Shakes in Sterling Gray and Pacific Blue and Monogram Double 4" Clapboard in Sterling Gray.
Trim: Vinyl Carpentry® & Restoration Millwork®.
Roof: Landmark® Series in Colonial Slate.



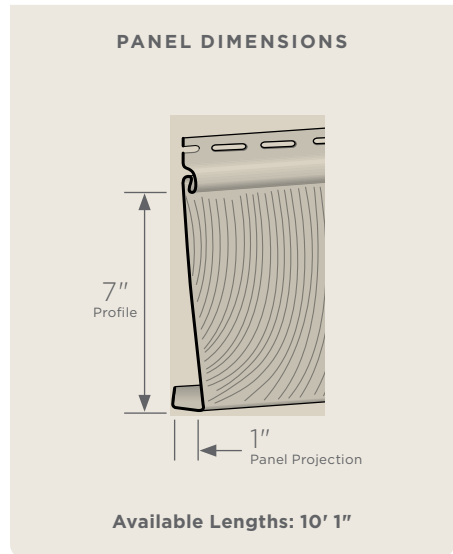
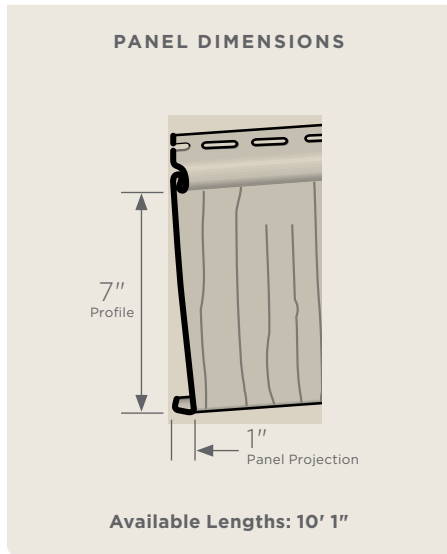
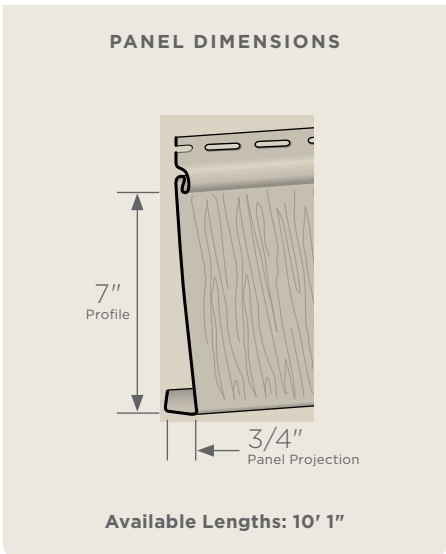

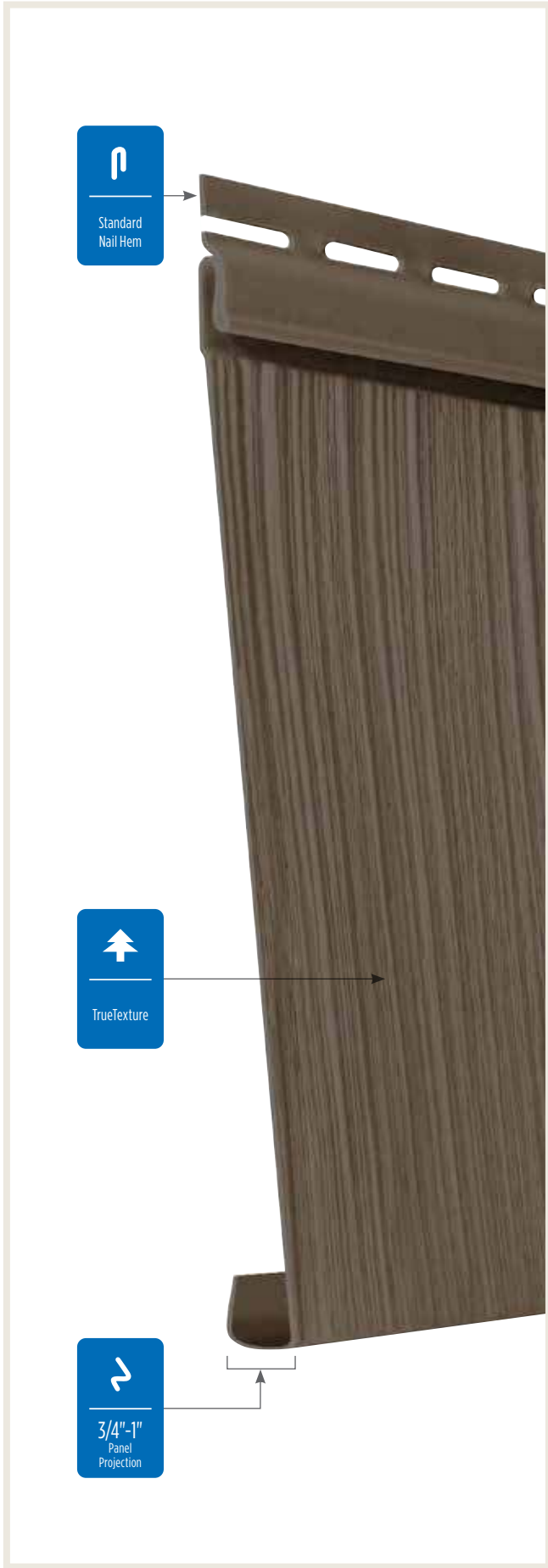

	S7 Straight Edge Perfection Shingles	S7 Straight Edge Rough-Split Shakes	S7 Straight Edge Sawmill Shingles	
Autumn Red	●	●		
Slate	●			
Espresso	●			
Sable Brown	●	●	●	
Midnight Blue	●		●	
Pacific Blue	●	●	●	
Flagstone	●	●	●	
Smoky Gray	●		●	
Charcoal Gray	●		●	
Castle Stone	●			
Granite Gray	●	●	●	
Sterling Gray	●	●	●	
Seagrass	●			
Cypress	●	●		
Herringbone	●			
Sandstone Beige	●	●		
Desert Tan	●	●		
Natural Clay	●	●	●	
Savannah Wicker	●	●	●	
Colonial White	●	●	●	



Siding: Northwoods Single 7" Straight Edge Rough-Split Shakes in Cypress with Monogram Double 4" Clapboard in Natural Clay.

Trim: Vinyl Carpentry® & Restoration Millwork®.

RISE[®] Siding and Trim

Composite Siding

NEW
PRODUCT



.375"



4
Siding Profiles



Woodgrain
& Smooth



30 Year
Limited Substrate
Warranty



Low
Maintenance

Siding: RISE siding painted gray.
Trim: RISE trim painted white.



Consult the Product Catalog (04-08-30-US-EN) for all available RISE Siding and Trim products.

- Looks, feels and installs like real wood
- Minimal expansion and contraction
- No decay, rot or freeze/thaw damage
- Available primed and pre-finished
- 30-Year Warranty

RISE Siding and Trim is available in primed or pre-painted finishes. Product sizes and pre-finish color availability varies by region. Please work with your local supplier for options and availability.

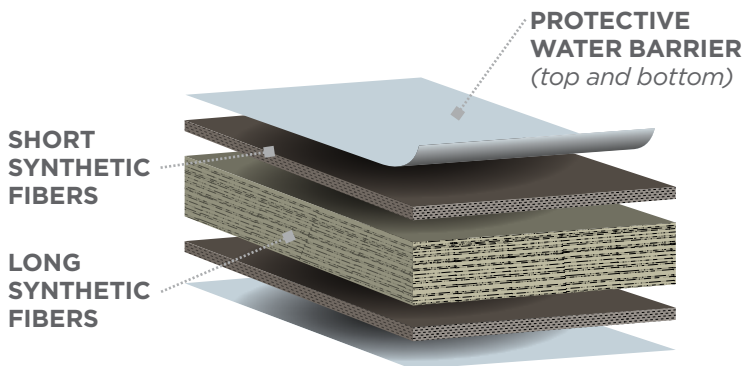









The patented manufacturing process compresses reclaimed synthetic fiber and polymer materials into dense and durable wood replacement products that come in smooth and woodgrain finishes.



All products siding and trim products available in both woodgrain and true smooth finishes.

Urban Reserve™ Aluminum Siding



- 
.027"
- 
1
- 
9
- 
2/5" Panel Projection
- 
Smooth
- 
40 Year Warranty
- 
Low Maintenance
- 
Class A Flame Spread

Siding: Urban Reserve Single 6" Panel in Commercial Brown.

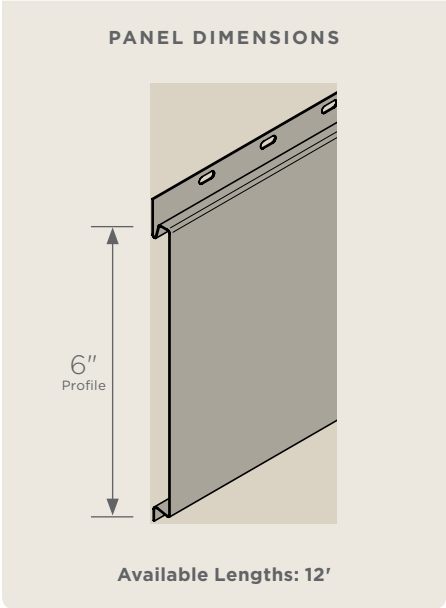
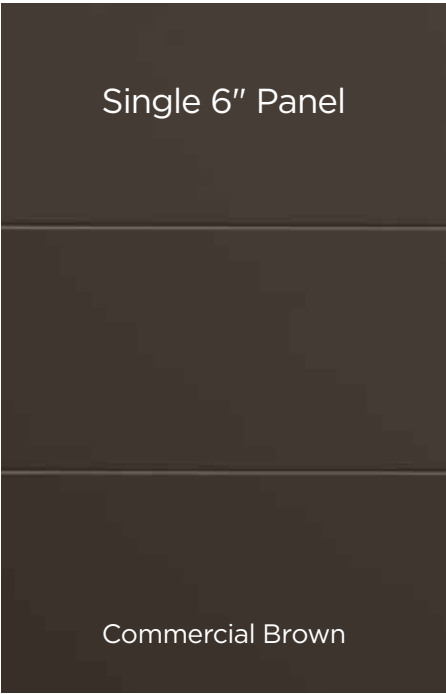

Matching Soffit, Accessories,
and Trim Coil available.

Aluminum
Soffit

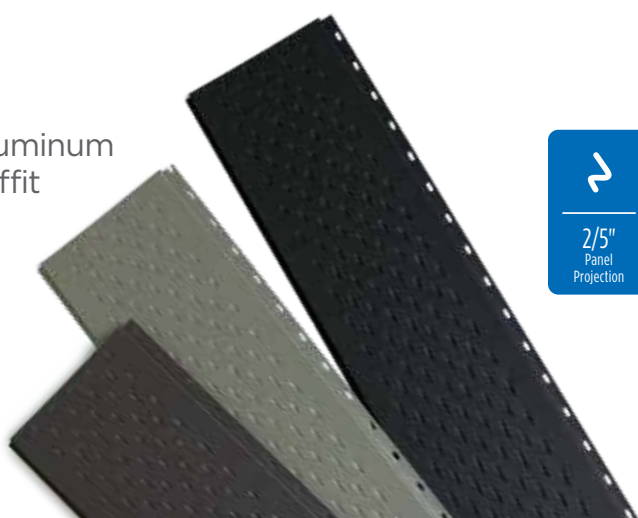





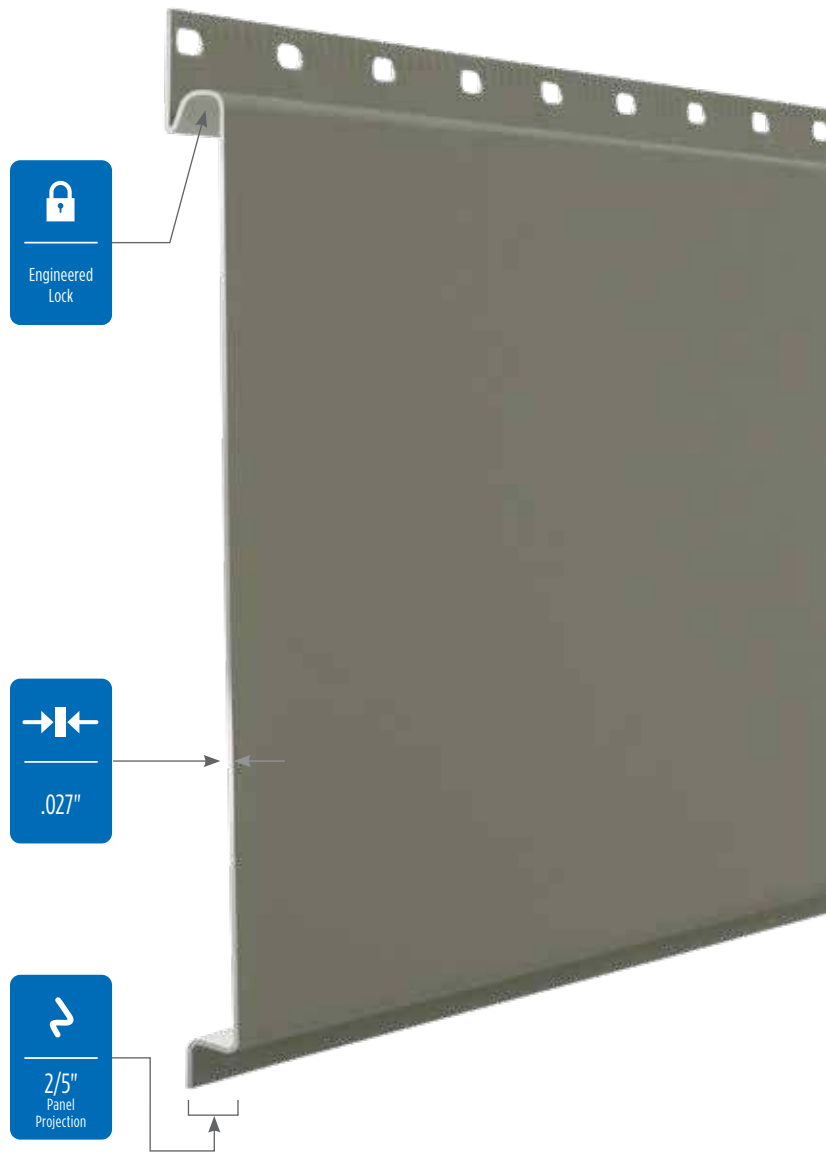



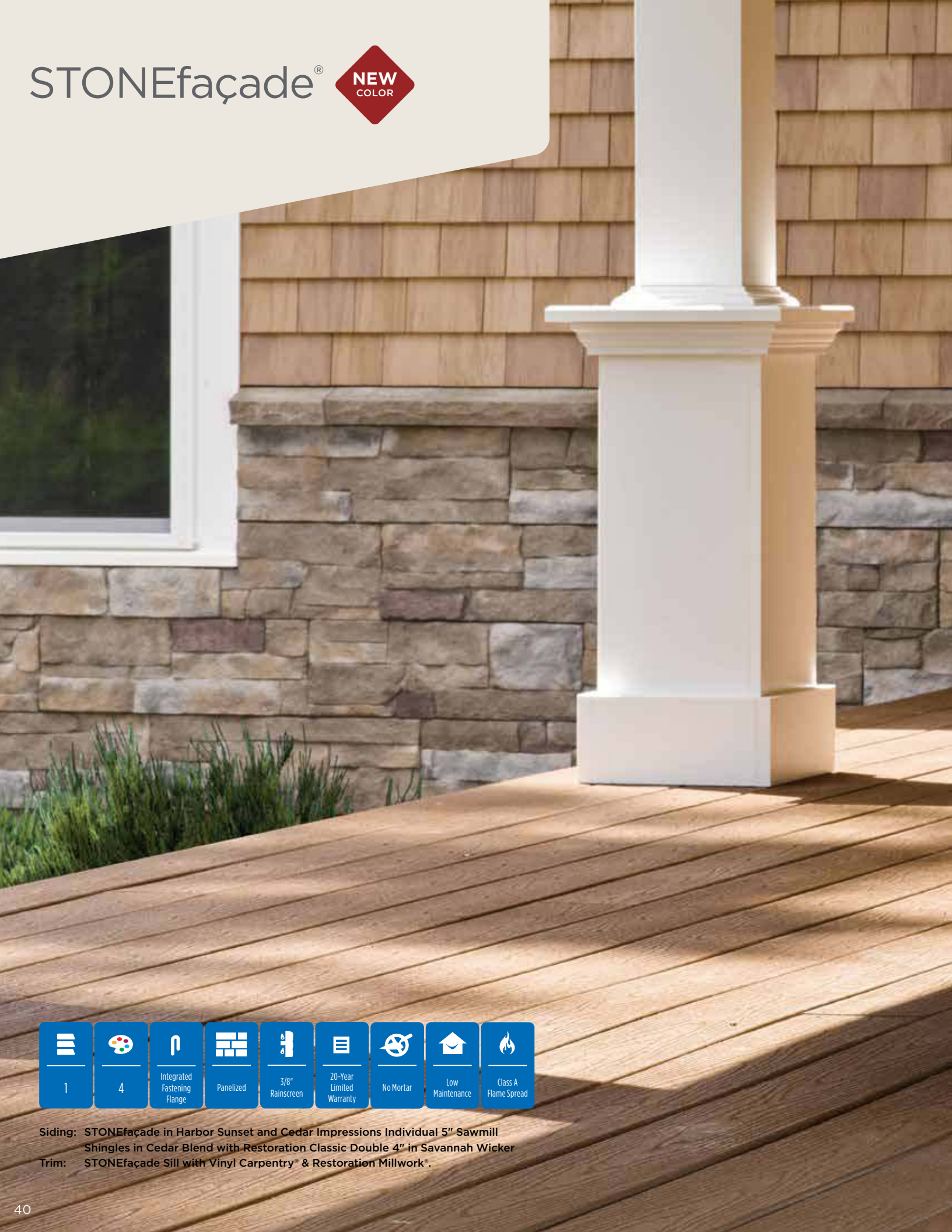

Commercial Brown	●	
Black LG	●	
Carbon Black	●	
Rustic Granite	●	
Brushed Pewter	●	
Charcoal Ash	●	
Grafton Grey	●	
Silver Bullet*	●	
Wolf White	●	

*Deluxe Colors



STONEfaçade®



- 
1
- 
4
- 
Integrated Fastening Flange
- 
Panelized
- 
3/8" Rainscreen
- 
20-Year Limited Warranty
- 
No Mortar
- 
Low Maintenance
- 
Class A Flame Spread

Siding: STONEfaçade in Harbor Sunset and Cedar Impressions Individual 5" Sawmill Shingles in Cedar Blend with Restoration Classic Double 4" in Savannah Wicker
Trim: STONEfaçade Sill with Vinyl Carpentry® & Restoration Millwork®.



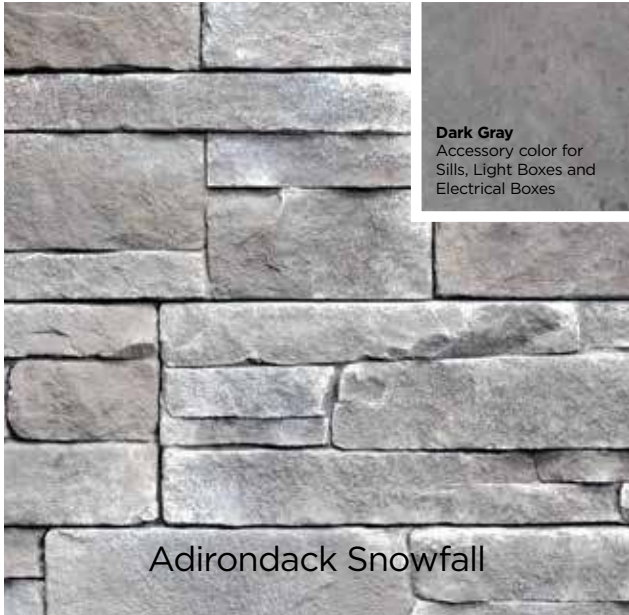

PANEL DIMENSIONS

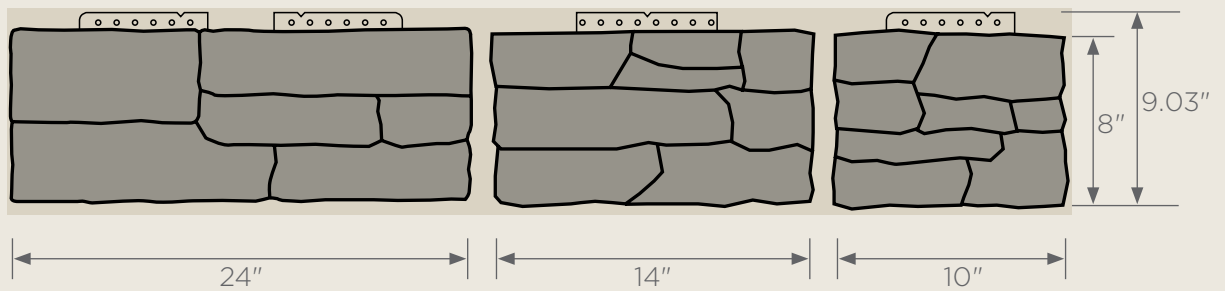

Product availability varies by region.

The patented fully-integrated rainscreen provides STONEfaçade additional structural support and superior drainage and will prevent moisture from accumulating in the wall cavity. The rainscreen insert also incorporates a fastening flange that allows STONEfaçade to be screwed to the substrate.



Oversized wrap around edge feature creates a more realistic and thicker finish compared to other stone veneer products that can have a thin appearance.



Easy-to-install stone veneer panels.

Finishing Touches

CertainTeed STONEfaçade includes a complete line of matching accessories.



Sills



Light Boxes



Electrical Boxes



Corners (Available in matching colors)

CedarBoards™

Insulated Siding

NEW
COLORS

Chosen by Builders and Remodelers as the
#1 Insulated Siding
in Brand Awareness, Performance and Use.



- .044" (D6, S7)
.052" (S12)
- 3
- up to 180mph (D6, S7)
- 18
- Full Rollover Nail Hem
- 1-1/4" Panel Projection
- TrueTexture Rough Cedar
- DuraLock
- Lifetime Limited Warranty
- STUDfinder
- Class A Flame Spread
- PermaColor Fade Protection
- Longer Lengths Available
- Low Maintenance
- Drainability

Siding: CedarBoards Single 7" Clapboard in Savannah Wicker with Cedar Impressions Double 7" Staggered Perfection in Natural Clay.
Trim: Vinyl Carpentry® & Restoration Millwork®.
Roof: Landmark® Promax in Weathered Wood.





Double 6"
Rough Cedar Clapboard

Flagstone



Single 7"
Rough Cedar Clapboard

Savannah Wicker



Single 12"
Rough Cedar
Board & Batten

Autumn Red

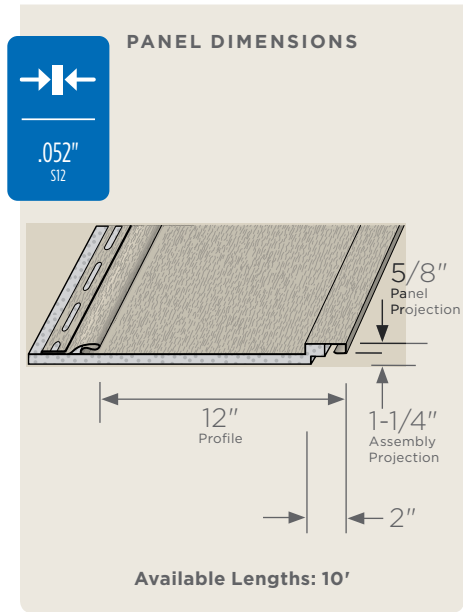
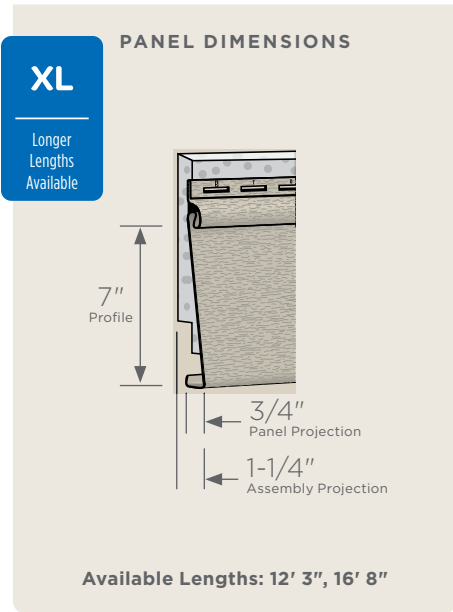
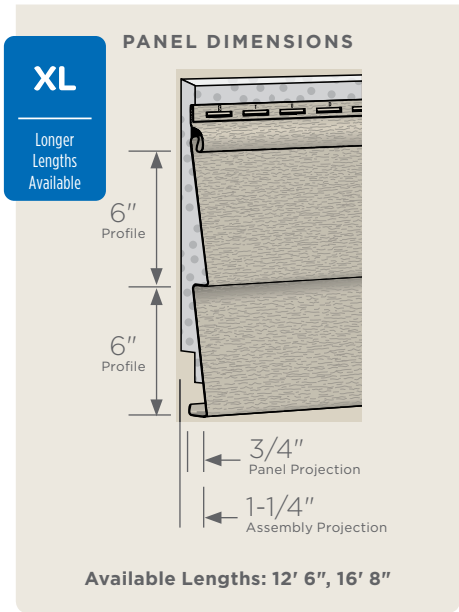

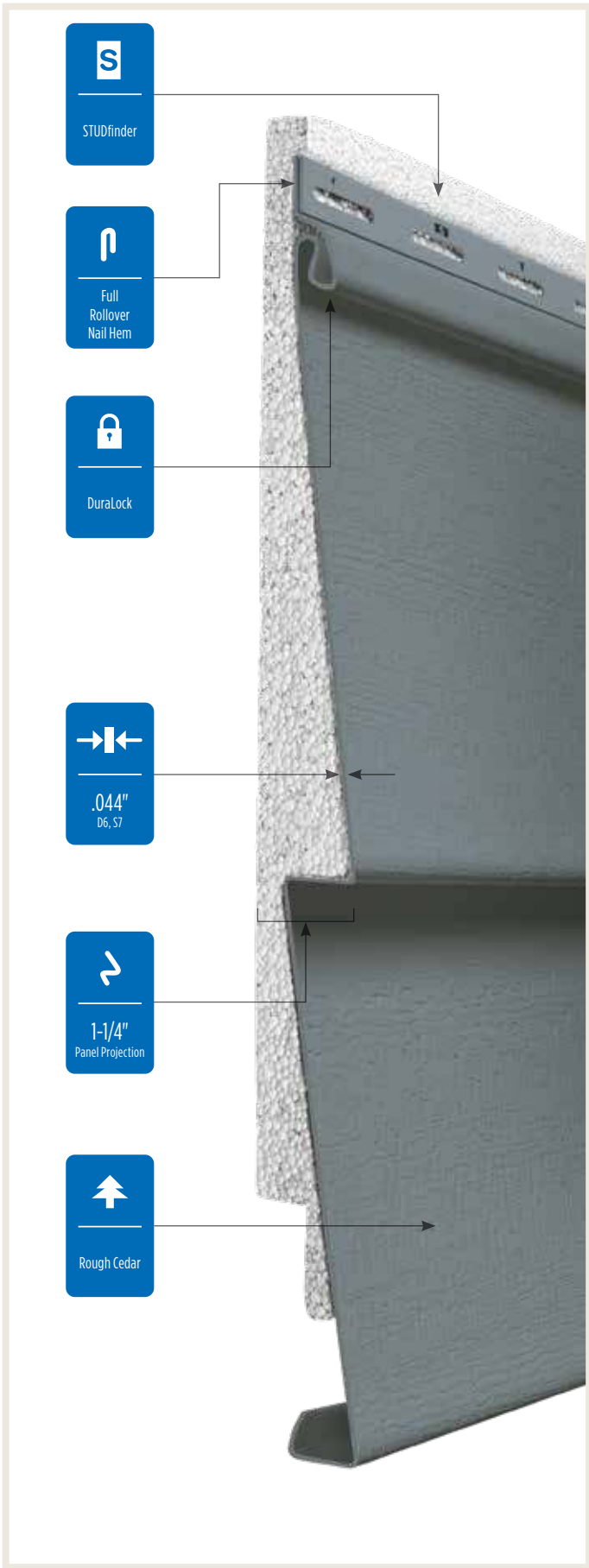

	D6 Clapboard	S7 Clapboard	S12 Board & Batten	XL D6 Clapboard	XL S7 Clapboard
Autumn Red*	●	●	●		
Sable Brown*	●	●			
Spruce*	●	●			
NEW COLOR Pacific Blue*	●		★	●	
NEW COLOR Flagstone*	●	●	★	●	●
NEW COLOR Charcoal Gray*	●	●	★	●	●
Granite Gray	●	●	●	●	●
Sterling Gray	●	●	●	●	●
Oxford Blue	●	●			
Cypress	●	●		●	●
NEW COLOR Herringbone	★	★	●		
Sandstone Beige	●	●			
Desert Tan	●	●			
Natural Clay	●	●	●	●	●
Savannah Wicker	●	●	●	●	●
Heritage Cream	●	●			
Snow			●		
Colonial White	●	●	●	●	●

★ New Color
*Deluxe Colors

Finishing Touches













A full line of Vinyl
Carpentry accessories
specially designed for use
with CedarBoards Siding.



CERTAp plank[®]

Reinforced Siding



- 
.046"
- 
1
- 
15
- 
Partial Rollover Nail Hem
- 
3/4" Panel Projection
- 
Woodgrain
- 
Post-Formed Positive Lock
- 
Lifetime Limited Warranty
- 
Class A Flame Spread
- 
STUDfinder
- 
PermaColor Fade Protection
- 
Low Maintenance

Siding: CERTAp plank Single 7" Clapboard in Flagstone.
Trim: Vinyl Carpentry[®] & Restoration Millwork[®].



Single 7" Clapboard

Savannah Wicker

PANEL DIMENSIONS

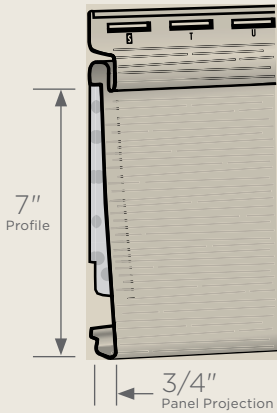

Available Lengths: 12' 4-1/2"

No unsightly gaps on finished walls



S7 Clapboard	
Sable Brown*	●
Forest*	●
Midnight Blue*	●
Pacific Blue*	●
Wedgewood Blue	●
Flagstone*	●
Smoky Gray	●
Charcoal Gray*	●
Castle Stone	●
Granite Gray	●
Sterling Gray	●
Herringbone	●
Natural Clay	●
Savannah Wicker	●
Colonial White	●

*Deluxe Colors

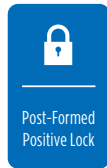

Reinforced Foam Backer









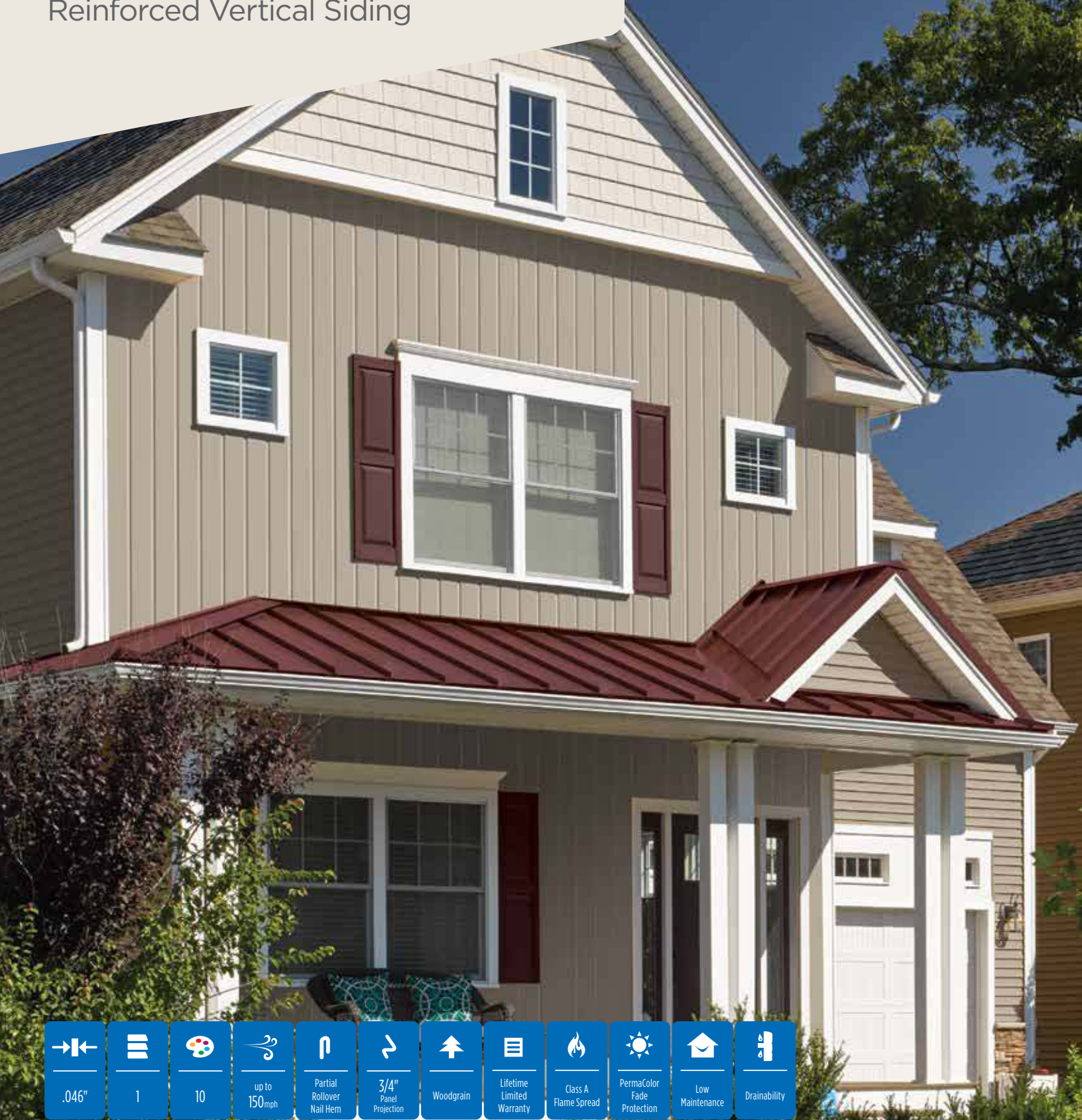



Combined with an extra thick panel to create rigidity and durability you'd expect from a hardboard cladding.



Reverse Board & Batten

Reinforced Vertical Siding



-  .046"
-  1
-  10
-  up to 150_{mph}
-  Partial Rollover Nail Hem
-  3/4" Panel Projection
-  Woodgrain
-  Lifetime Limited Warranty
-  Class A Flame Spread
-  PermaColor Fade Protection
-  Low Maintenance
-  Drainability

Siding: Reverse Board & Batten Single 7" Reinforced Vertical Siding and Restoration Classic Double 4-1/2" Natural Clay, Cedar Impressions Double 7" Straight Edge Perfection Shingles in Herringbone with Ironmax Double 5" Vented Soffit in Colonial White.
 Trim: Vinyl Carpentry® & Restoration Millwork®.

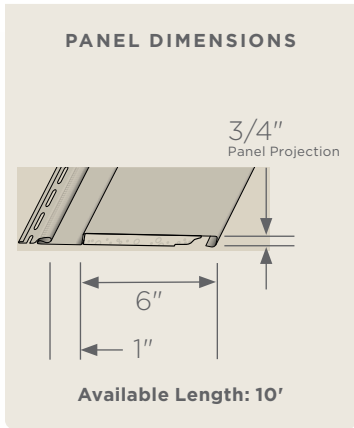
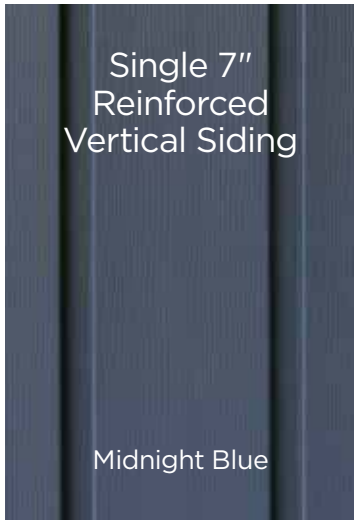

S7

Reverse Board & Batten

Autumn Red*	●	
Sable Brown*	●	
Midnight Blue*	●	
Pacific Blue*	●	
Charcoal Gray*	●	
Granite Gray	●	
Sterling Gray	●	
Natural Clay	●	
Savannah Wicker	●	
Colonial White	●	













*Deluxe Colors



Board & Batten

Vertical Siding



-  .052"
S7
-  .048"
S8
-  3
-  30
-  up to
165mph
-  Standard
Nail Hem
-  1/2"
Panel
Projection
-  TrueTexture
Rough Cedar
-  Lifetime
Limited
Warranty
-  Class A
Flame Spread
-  PermaColor
Fade
Protection
-  Low
Maintenance
-  Drainability

Siding: Board & Batten Single 7" in Colonial White with Monogram® Double 5" Clapboard in Natural Clay.
Trim: Vinyl Carpentry® & Restoration Millwork®

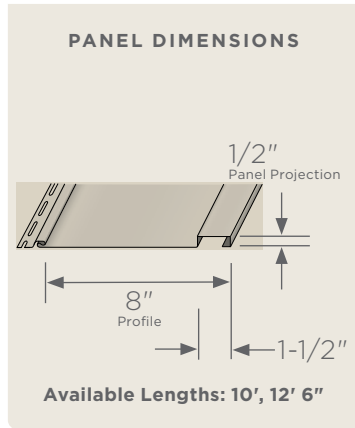
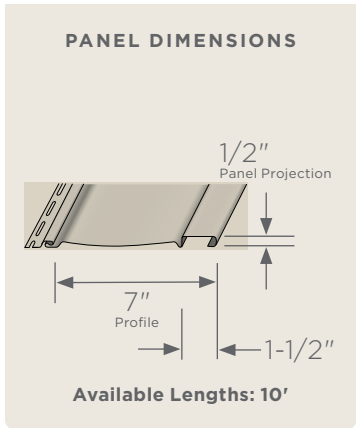
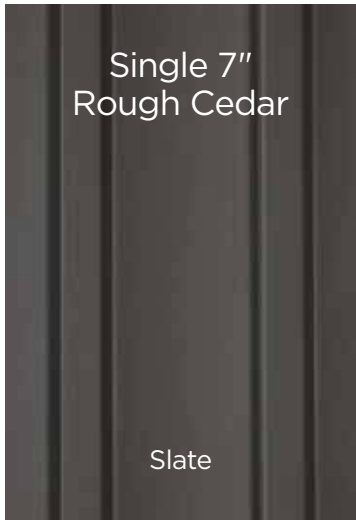

NEW
COLOR

NEW
COLOR

NEW
COLOR

	S7 Board & Batten	S8 Board & Batten	S12 Board & Batten
Brownstone*	●		
Melrose*	●		
Autumn Red*	●		●
Tuxedo*	●		
Slate*	●		
Espresso*	●		
Sable Brown*	●		
Sparrow*	●		
Spruce*	●		
Forest*	●		
Midnight Blue*	●		
Deep Mineral*	●		
Pacific Blue*	●		★
Wedgewood Bue	●		
Flagstone*	●		★
Smoky Gray	●		
Charcoal Gray*	●		★
Castle Stone	●		
Granite Gray	●	●	●
Graystone	●	●	
Sterling Gray	●	●	●
Cypress	●	●	
Herringbone	●	●	●
Sandstone Beige		●	
Desert Tan		●	
Weathered Wood	●		
Natural Clay	●	●	●
Savannah Wicker	●	●	●
Snow		●	●
Colonial White	●	●	●

★ New Color
*Deluxe Colors



Monogram[®]



.046"	3	40	up to 210 _{mph}	Full Rollover Nail Hem	3/4" Panel Projection	TrueTexture Rough Cedar	CertiLock	Lifetime Limited Warranty	STUDfinder	Class A Flame Spread	PermaColor Fade Protection	Longer Lengths Available	Low Maintenance	Drainability

Siding: Monogram Double 4" Clapboard in Flagstone with Cedar Impressions Individual 5" Sawmill Shingles in Driftwood Blend and STONEfaçade in Adirondack Snowfall.

Trim: Vinyl Carpentry[®].

Columns: Tapered Round.





Double 4"
Rough Cedar Clapboard

Brownstone



Double 5"
Rough Cedar Clapboard

Wedgewood Blue



Double 5"
Rough Cedar Dutchlap

Driftwood Blend

XL
Longer Lengths Available

PANEL DIMENSIONS

4" Profile
4" Profile
3/4" Panel Projection

Available Lengths: 12' 6", 16' 8", 20', 25'

PANEL DIMENSIONS

5" Profile
5" Profile
3/4" Panel Projection

Available Lengths: 12'

XL
Longer Length Available

PANEL DIMENSIONS

5" Profile
5" Profile
3/4" Panel Projection

Available Lengths: 12', 16'



	D4 Clapboard	D5 Clapboard	D5 Dutchlap	XL Clapboard	XL Dutchlap
Arbor Blend**	●		●		
Weathered Blend**	●		●		
Frontier Blend**	●		●		
Natural Blend**	●		●		
Driftwood Blend**	●		●		
Cedar Blend**	●		●		
Rustic Blend**	●		●		
Brownstone*	●	●	●	●	
Melrose*	●	●	●	●	
Autumn Red*	●	●	●		
Tuxedo*	●	●	●		
Slate*	●	●	●	●	
Espresso*	●	●	●	●	
Sable Brown*	●	●	●	●	
Sparrow*	●	●	●		
Spruce*	●	●	●		
Olive Grove*	●	●	●		
Forest*	●	●	●		
Midnight Blue*	●	●	●	●	
Deep Mineral*	●	●	●		
Pacific Blue*	●	●	●	●	
Wedgewood Blue	●	●	●		
Flagstone*	●	●	●		
Smoky Gray	●	●	●		
Charcoal Gray*	●	●	●	●	
Castle Stone	●	●	●	●	
Granite Gray	●	●	●	●	●
Graystone	●	●	●		
Sterling Gray	●	●	●	●	●
Oxford Blue	●	●	●	●	●
Seagrass	●	●	●		
Cypress	●	●	●	●	●
Herringbone	●	●	●		
Sandstone Beige	●	●	●		
Desert Tan	●	●	●		
Weathered Wood	●	●	●		
Natural Clay	●	●	●	●	●
Savannah Wicker	●	●	●	●	●
Heritage Cream	●	●	●	●	●
Colonial White	●	●	●	●	●









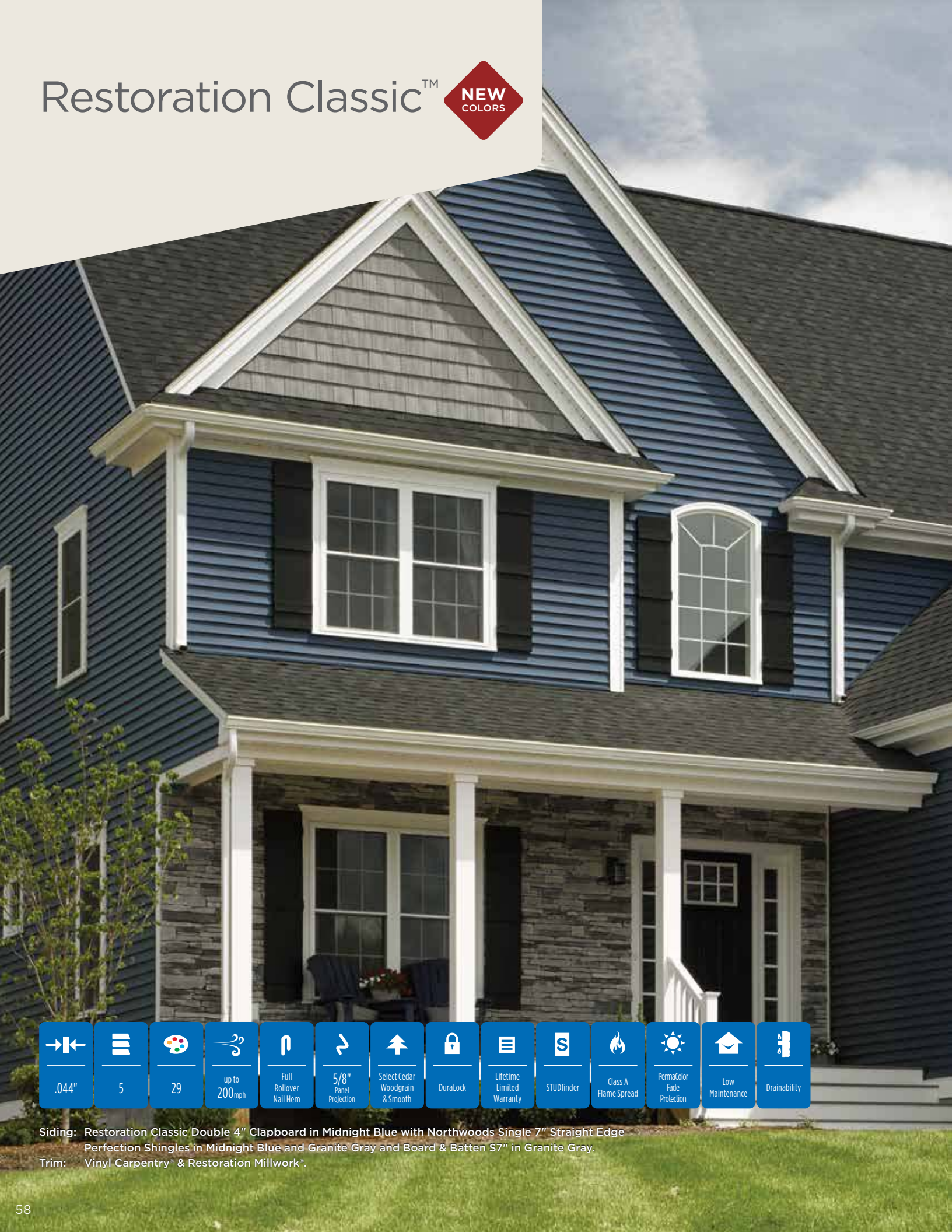





**Premium Colors

*Deluxe Colors

All blends have matching variegated outside corner posts available.

Restoration Classic™



-  .044"
-  5
-  29
-  up to 200_{mph}
-  Full Rollover Nail Hem
-  5/8" Panel Projection
-  Select Cedar Woodgrain & Smooth
-  DuraLock
-  Lifetime Limited Warranty
-  STUDfinder
-  Class A Flame Spread
-  PermaColor Fade Protection
-  Low Maintenance
-  Drainability

Siding: Restoration Classic Double 4" Clapboard in Midnight Blue with Northwoods Single 7" Straight Edge Perfection Shingles in Midnight Blue and Granite Gray and Board & Batten S7" in Granite Gray.
Trim: Vinyl Carpentry® & Restoration Millwork®.



Double 4"
Select Cedar Clapboard

Smoky Gray



PANEL DIMENSIONS

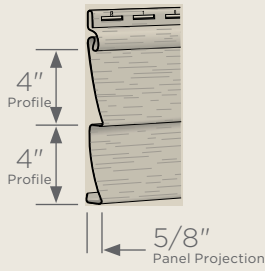

Available Lengths: 12' 6"

Double 4-1/2"
Select Cedar Dutchlap

Olive Grove



PANEL DIMENSIONS

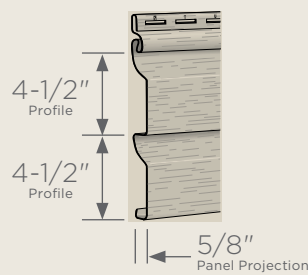

Available Lengths: 12' 1"

Double 5"
Select Cedar Clapboard

Heritage Cream



PANEL DIMENSIONS

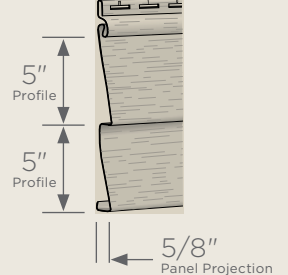

Available Lengths: 12'

Double 4-1/2"
Smooth Clapboard

Natural Clay



PANEL DIMENSIONS

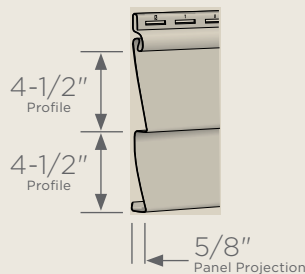

Available Lengths: 12' 1"

Triple 3"
Smooth Clapboard

Cypress



PANEL DIMENSIONS

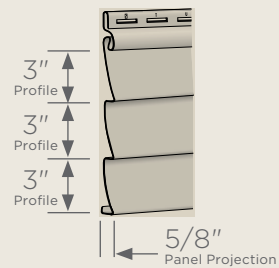

Available Lengths: 12' 1"

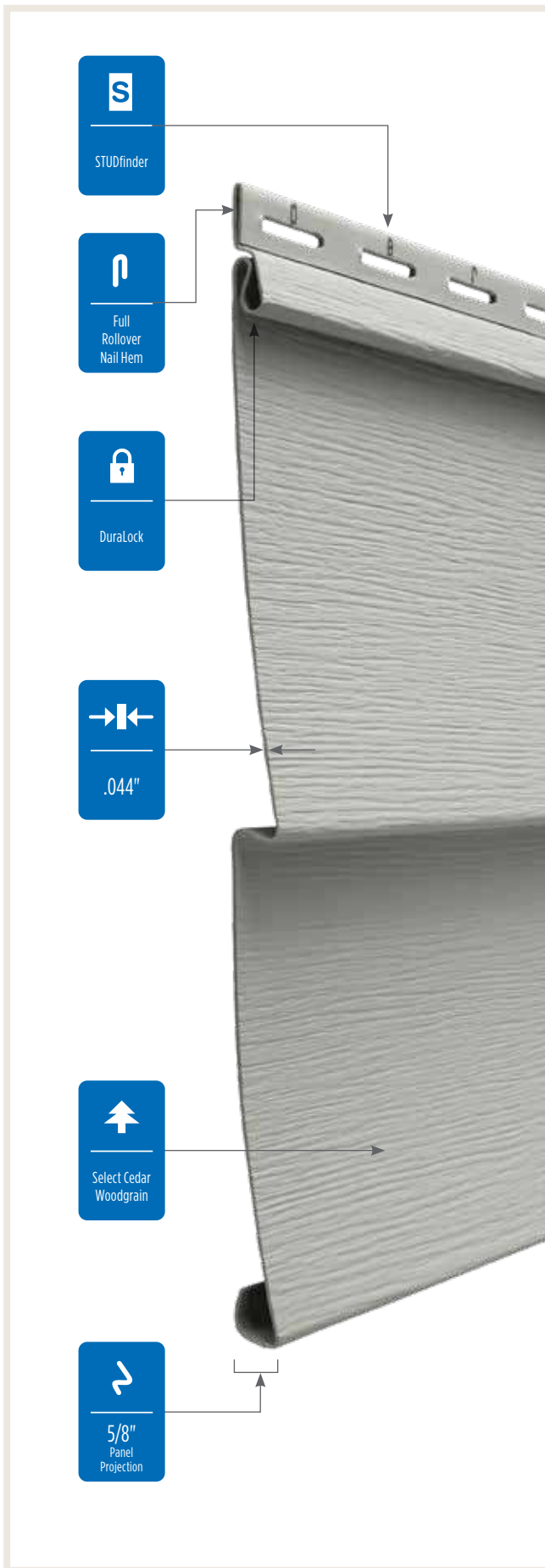

	D4 Clapboard	D4 ^{1/2} Dutchlap	D5 Clapboard	D4 ^{1/2} Clapboard	T3 Clapboard
Melrose*	●	●			
Autumn Red*	●	●			
Slate*	●	●			
Espresso*	●	●			
Sable Brown*	●	●			
Spruce*	●	●			
Olive Grove*	●	●			
Forest*	●	●			
Midnight Blue*	●	●			
Pacific Blue*	●	●			
NEW COLOR Wedgewood Blue	★	★			
Flagstone*	●	●			
Smoky Gray	●	●			
Charcoal Gray*	●	●			
Castle Stone	●	●			
Granite Gray	●	●	●	●	●
NEW COLOR Graystone	★	★			
Sterling Gray	●	●	●	●	●
Oxford Blue	●	●	●		
Seagrass	●	●	●		
Cypress	●	●	●	●	●
Herringbone	●	●	●	●	●
Desert Tan	●	●	●		
NEW COLOR Weathered Wood	★	★			
Natural Clay	●	●	●	●	●
Savannah Wicker	●	●	●	●	●
Heritage Cream	●	●	●		
Autumn Yellow	●	●	●		
Colonial White	●	●	●	●	●















★ New Color
 *Deluxe Colors



Siding: Restoration Classic Double 4" Clapboard in Espresso.
 Trim: Vinyl Carpentry® & Restoration Millwork®.

Carolina Beaded™



-  .044"
-  1
-  14
-  up to 130_{mph}
-  Standard Nail Hem
-  3/4" Panel Projection
-  Brushed
-  Post-formed
-  Lifetime Limited Warranty
-  STUDfinder
-  Class A Flame Spread
-  PermaColor Fade Protection
-  Low Maintenance
-  Drainability

Siding: Carolina Beaded Single 6-1/2" in Heritage Cream.
Trim: Vinyl Carpentry® & Restoration Millwork®.

Single 6-1/2"
Brushed Beaded



Granite Gray

PANEL DIMENSIONS

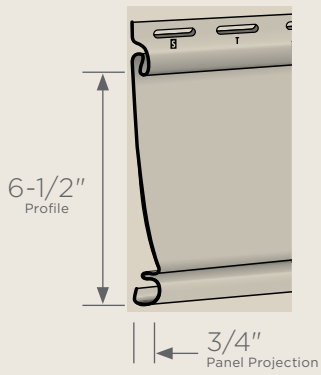

Available Lengths: 12' 4"





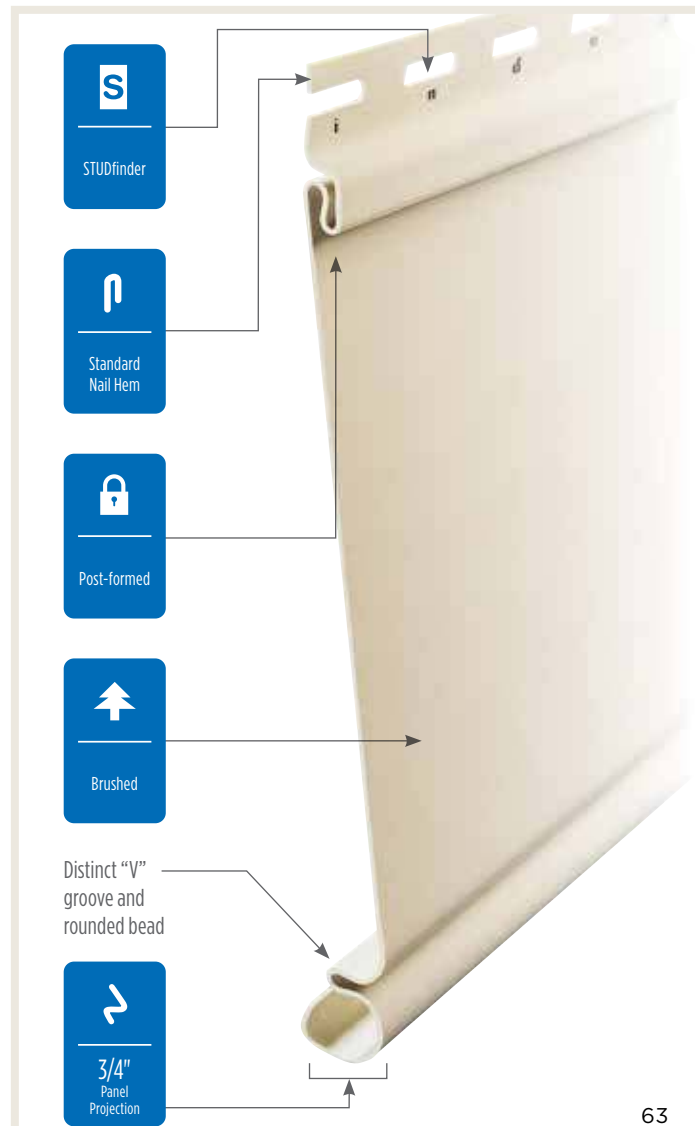



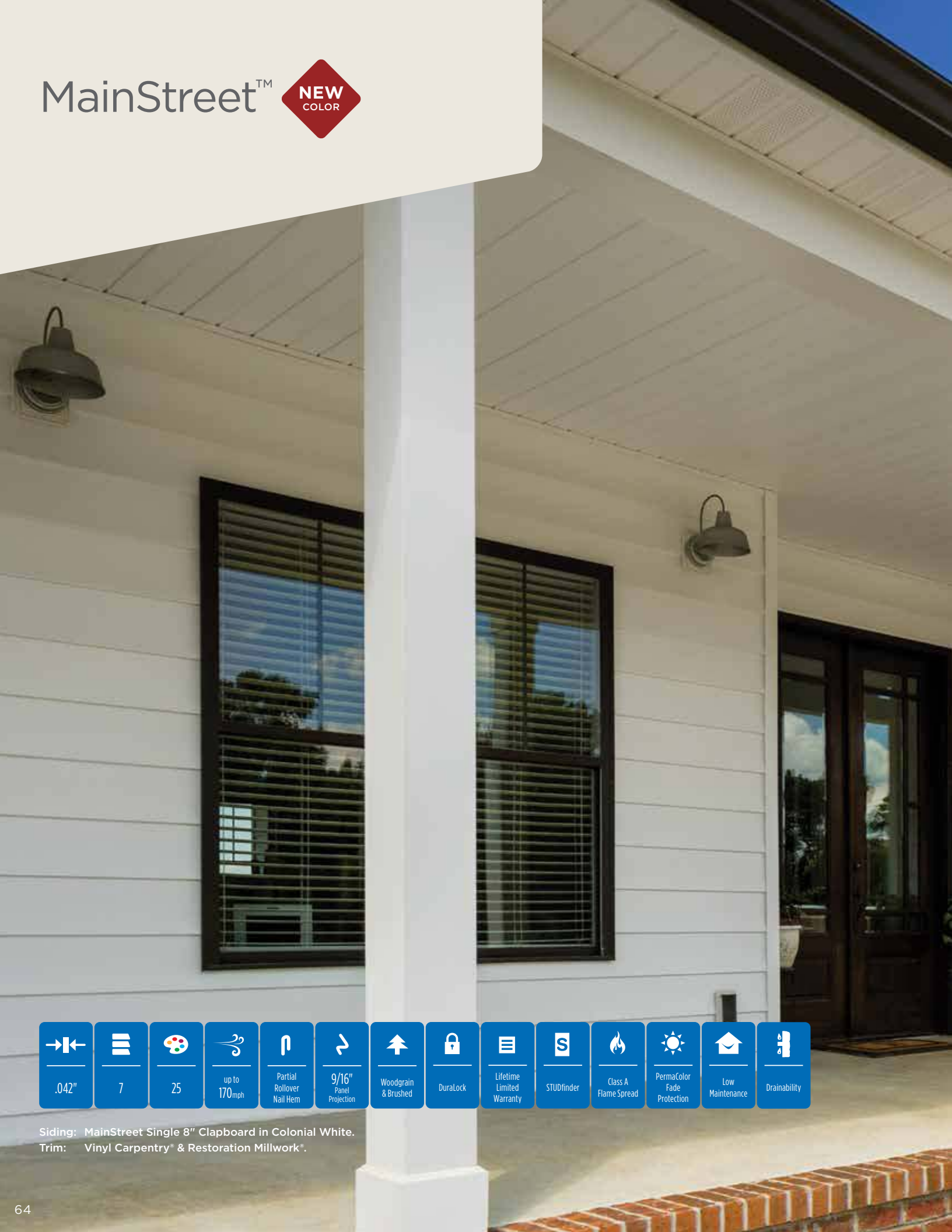





S6^{1/2}
Beaded

Castle Stone	●
Granite Gray	●
Sterling Gray	●
Oxford Blue	●
Seagrass	●
Cypress	●
Herringbone	●
Sandstone Beige	●
Desert Tan	●
Natural Clay	●
Savannah Wicker	●
Heritage Cream	●
Snow	●
Colonial White	●



MainStreet™



- 
.042"
- 
7
- 
25
- 
up to 170_{mph}
- 
Partial Rollover Nail Hem
- 
9/16" Panel Projection
- 
Woodgrain & Brushed
- 
DuraLock
- 
Lifetime Limited Warranty
- 
STUDfinder
- 
Class A Flame Spread
- 
PermaColor Fade Protection
- 
Low Maintenance
- 
Drainability

Siding: MainStreet Single 8" Clapboard in Colonial White.
Trim: Vinyl Carpentry® & Restoration Millwork®.



Double 4"
Woodgrain
Clapboard



Natural Clay

Double 5"
Woodgrain
Clapboard



Herringbone

Double 4"
Woodgrain
Dutchlap



Granite Gray

Double 5"
Woodgrain
Dutchlap



Forest

Triple
Brush
Clapboard



Desert

PANEL DIMENSIONS

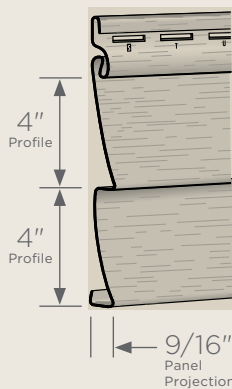

Available Lengths: 12' 6"

PANEL DIMENSIONS

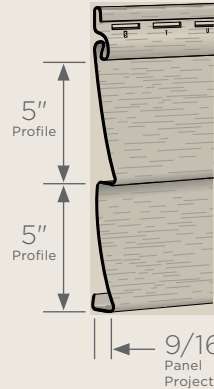

Available Lengths: 12'

PANEL DIMENSIONS

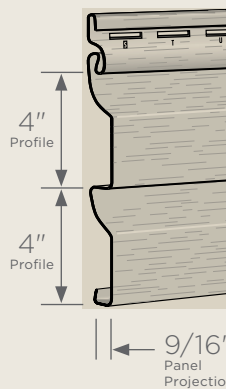

Available Lengths: 12' 6"

PANEL DIMENSIONS

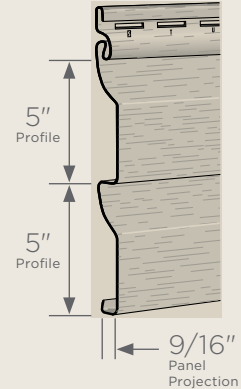

Available Lengths: 12'

PANEL DIMENSIONS

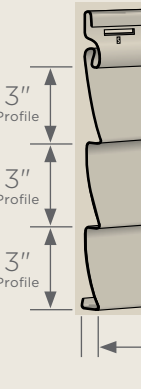

Available Lengths: 12'





3"
ed
board

Tan



Single 6-1/2"
Brushed
Beaded

Cypress



Single 8"
Woodgrain
Clapboard

Colonial White

NEW
COLOR

	D4 Clapboard	D5 Clapboard	D4 Dutchlap	D5 Dutchlap	T3 Clapboard	S6 1/2 Beaded	S8 Clapboard
Autumn Red*	●	●	●	●			
Sable Brown*	●	●	●	●			
Spruce*	●	●	●	●			
Forest*	●	●	●	●			
Pacific Blue*	●	●	●	●			
Wedgewood Blue	●	●	●	●			
Flagstone*	●	●	●	●			
Charcoal Gray*	●	●	●	●			
Castle Stone	●	●	●	●			
Granite Gray	●	●	●	●		●	
Graystone	★	★	★	★			
Sterling Gray	●	●	●	●	●	●	
Oxford Blue	●	●	●	●	●		
Seagrass	●	●	●	●			
Cypress	●	●	●	●		●	
Herringbone	●	●	●	●			
Sandstone Beige	●	●	●	●	●	●	
Desert Tan	●	●	●	●	●	●	
Weathered Wood	●	●	●	●			
Natural Clay	●	●	●	●	●	●	
Savannah Wicker	●	●	●	●	●	●	
Heritage Cream	●	●	●	●			
Autumn Yellow	●	●	●	●			
Snow	●	●	●	●	●		
Colonial White	●	●	●	●	●	●	●



ENSIONS

9/16"
Panel
Projection
Available Lengths: 12' 1"

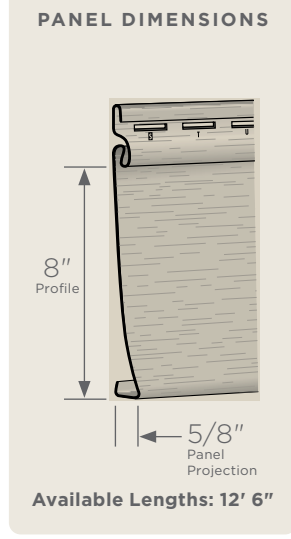
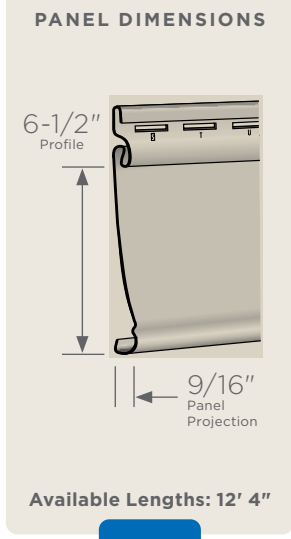

★ New Color
*Deluxe Colors

















Siding: MainStreet Double 4" Clapboard in Forest.
MainStreet Double 4" Clapboard in Natural Clay with Universal T4 solid soffit in Autumn Red applied vertically.
MainStreet Double 4" Clapboard in Desert Tan with Cedar Impressions S7" Straight Edge Perfection Shingles in Cypress.

Trim: Vinyl Carpentry® & Restoration Millwork*.

American Legend™



-  .042"
-  3
-  18
-  up to 140_{mph}
-  Standard Nail Hem
-  9/16" Panel Projection
-  Woodgrain
-  GripLock
-  Lifetime Limited Warranty
-  STUDfinder
-  Class A Flame Spread
-  PermaColor Fade Protection
-  Low Maintenance
-  Drainability

Siding: American Legend Double 4" Clapboard in Charcoal Gray.
Trim: Vinyl Carpentry® & Restoration Millwork®.

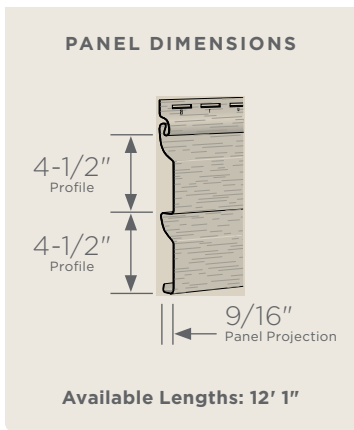
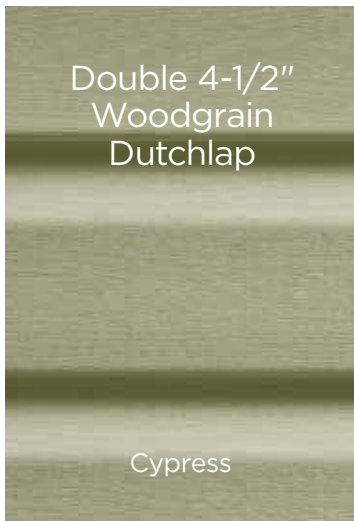
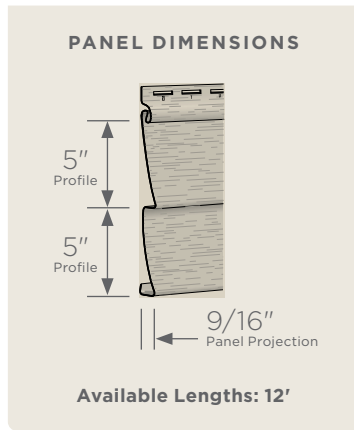
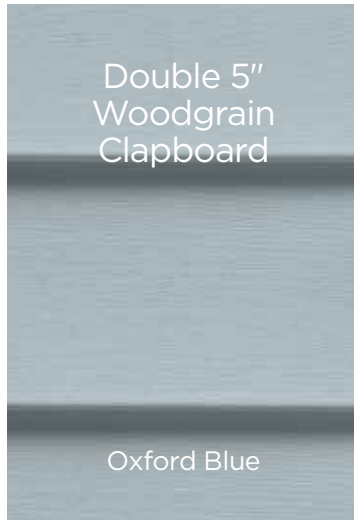
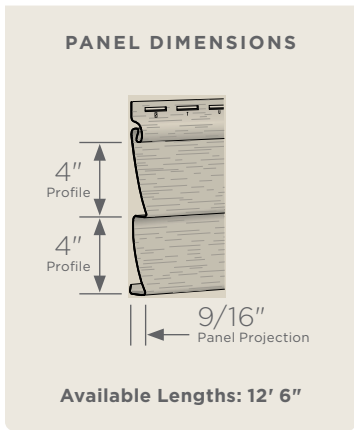
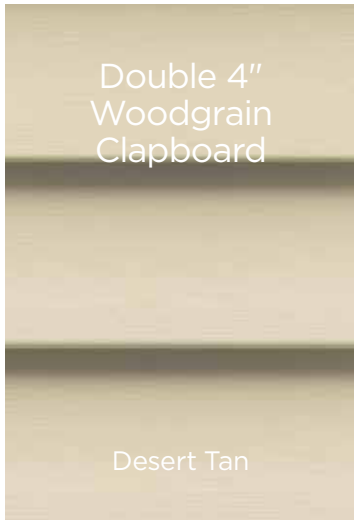





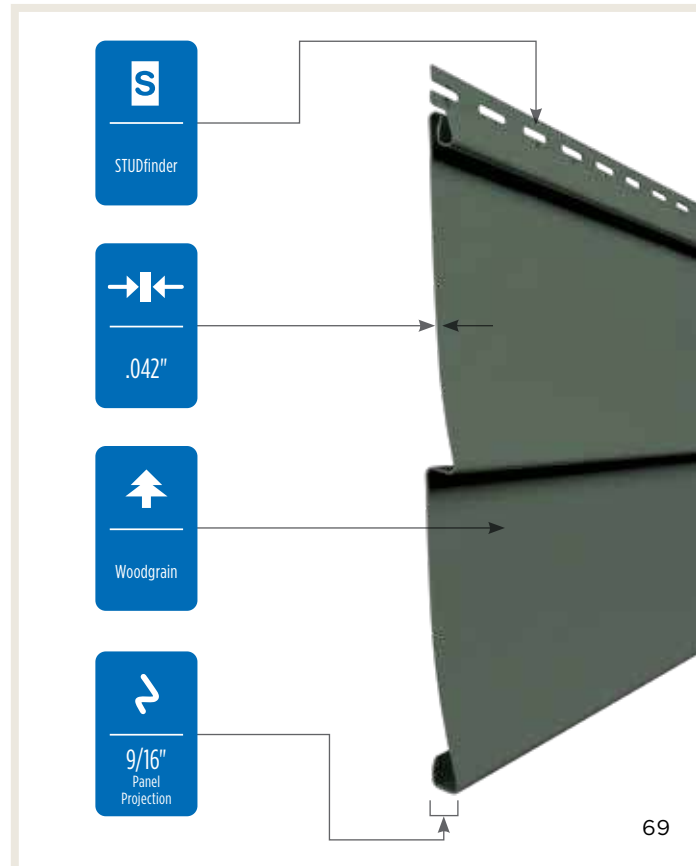







	D4 Clapboard	D5 Clapboard	D4 ^{1/2} Dutchlap
Autumn Red*	●	●	●
Spruce*	●	●	●
Forest*	●	●	●
Flagstone*	●	●	●
Charcoal Gray*	●	●	●
Granite Gray	●	●	●
Sterling Gray	●	●	●
Oxford Blue	●	●	●
Seagrass	●	●	●
Cypress	●	●	●
Herringbone	●	●	●
Desert Tan	●	●	●
Natural Clay	●	●	●
Savannah Wicker	●	●	●
Heritage Cream	●	●	●
Autumn Yellow	●	●	●
Snow	●	●	●
Colonial White	●	●	●

*Deluxe Colors



Encore™



- 
.040"
- 
3
- 
13
- 
up to 170_{mph}
- 
Partial Rollover Nail Hem
- 
1/2" Panel Projection
- 
Woodgrain
- 
Post-formed
- 
Lifetime Limited Warranty
- 
STUDfinder
- 
Class A Flame Spread
- 
PermaColor Fade Protection
- 
Low Maintenance
- 
Drainability

Siding: Encore Double 4" Clapboard in Desert Tan.
Trim: Vinyl Carpentry® & Restoration Millwork®.

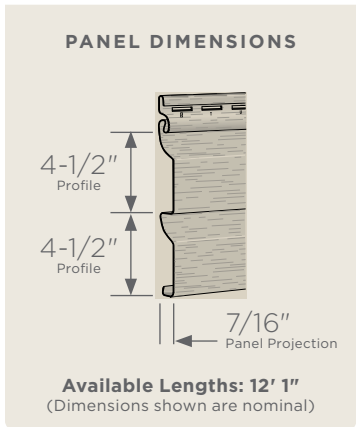
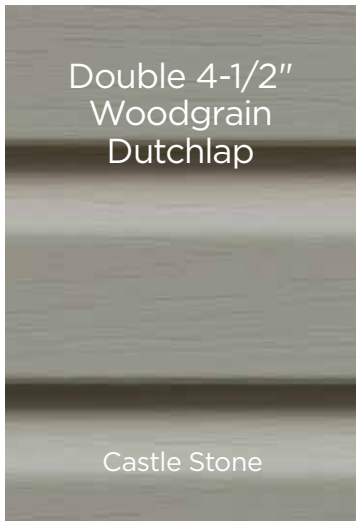
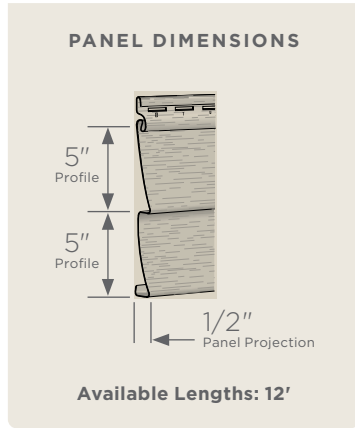
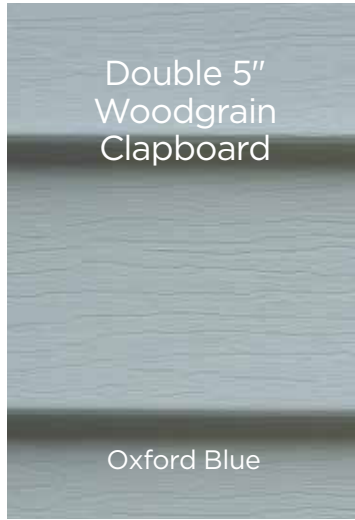
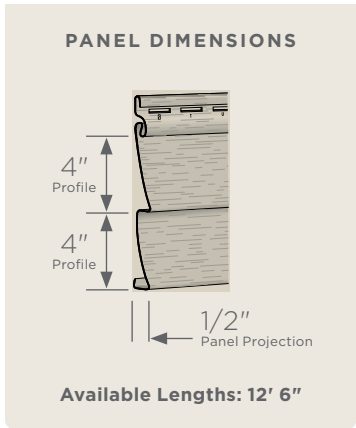
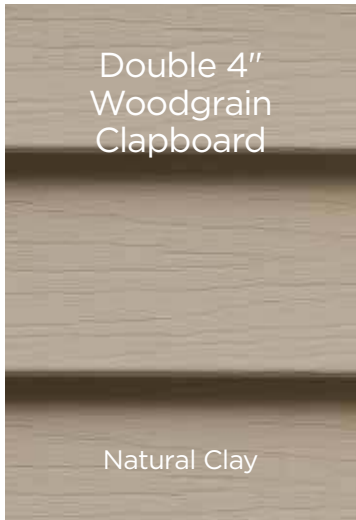

	D4 Clapboard	D5 Clapboard	D4 ^{1/2} Dutchlap	
Castle Stone	●	●	●	
Sterling Gray	●	●	●	
Oxford Blue	●	●	●	
Seagrass	●	●	●	
Cypress	●	●	●	
Natural Clay	●	●	●	
Herringbone	●	●	●	
Sandstone Beige	●	●	●	
Desert Tan	●	●	●	
Savannah Wicker	●	●	●	
Heritage Cream	●	●	●	
Snow	●	●	●	
Colonial White	●	●	●	

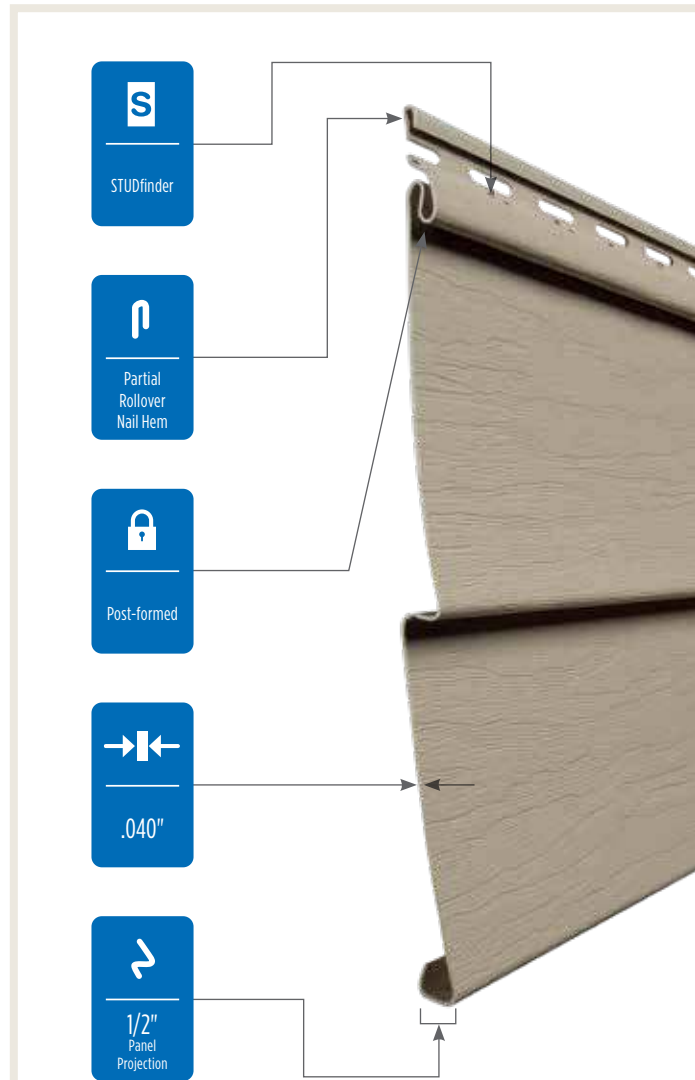

Soffit & Vertical Siding

Vinyl and Aluminum

Proper Ventilation is Critical

Protection against damage to the roofing materials and structure increase comfort inside the home and energy savings.

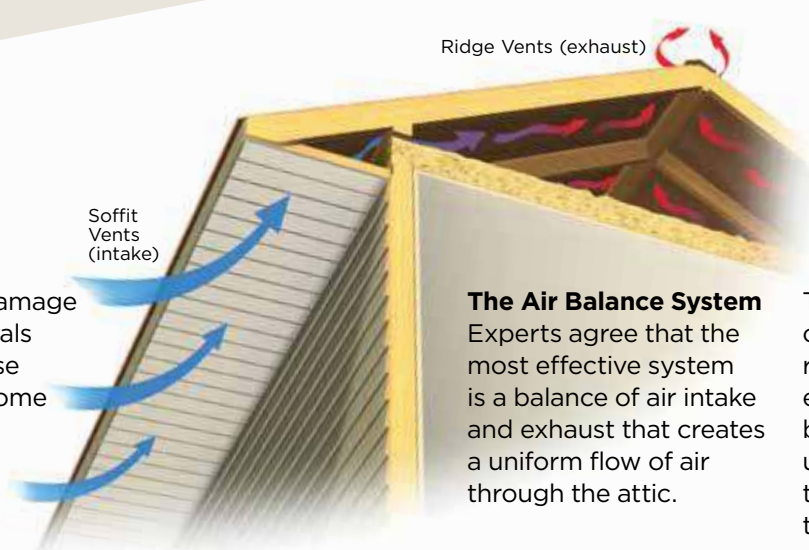

The Air Balance System

Experts agree that the most effective system is a balance of air intake and exhaust that creates a uniform flow of air through the attic.

This system creates a condition in which the roof temperature is equalized from top to bottom, supplying a uniform air flow along the entire underside of the roof deck.



Triple 3-1/3" InvisiVent



Standard vented soffit

Hidden vents provide a smooth, flat non-perforated surface versus most vented soffits with unsightly perforations.



Triple 3-1/3" InvisiVent offers at least 50% more ventilation than most standard vinyl soffit, providing more than 10" of net-free intake area. This means that not only will InvisiVent provide a balanced ventilation system, but will do so with an overhang as short as 10".

	T3 ^{1/3} InvisiVent	T3 ^{1/3} Perimeter	T2 Beaded
Black** soffit use only	★	●	
Charcoal Gray		●	
Granite Gray	●	●	
Sterling Gray			●
Bermuda Blue			●
Herringbone		●	
Sandstone Beige	●	●	●
Desert Tan	●	●	●
Natural Clay	●	●	●
Savannah Wicker	●	●	●
Snow	●	●	●
Colonial White	●	●	●

** Premium Colors

★ New Color



Triple 3-1/3" InvisiVent in Colonial White.

Invisivent[®] Triple 3-1/3"

Vinyl Soffit & Vertical Siding

- InvisiVent[®] hidden vent and solid styles.
- The only vinyl soffit to provide more than 10 inches of net-free intake area per square foot.
- Concealed intake vents provide a smooth appearance.
- Matte finish looks like freshly painted wood.
- Deep 3/4" panel projection creates sharp definition.
- 8 low-gloss colors.
- Heavy-duty .044" thickness for rigidity.

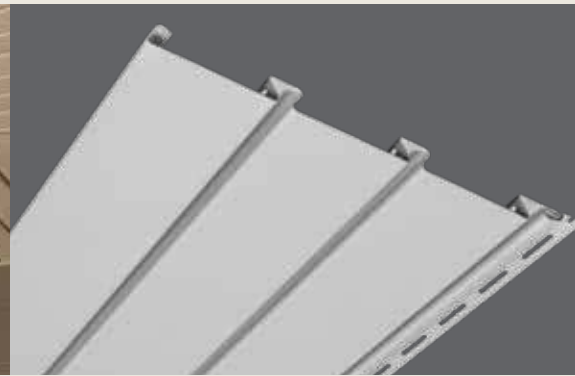

Perimeter[™] Triple 3-1/3"

Vinyl Soffit & Vertical Siding

- Hidden Vent and Solid Styles.
- 10 low-gloss colors.
- .040" thickness.
- Hidden vent style provides up to 9.65 inches of net-free intake area per square foot.

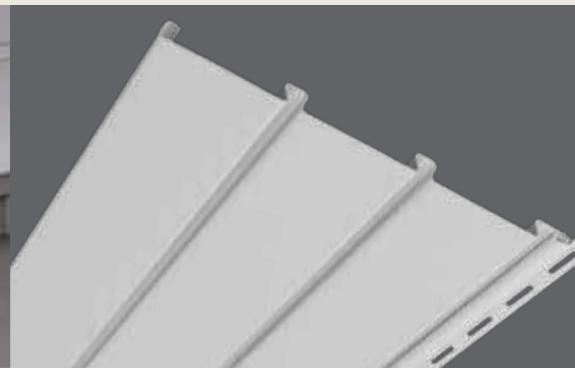

Beaded Triple 2"

Vinyl Soffit & Vertical Siding

- Wainscot style in solid and invisibly vented.
- Designed for vertical siding, porch ceiling and soffit applications.
- Smooth finish of professionally applied paint.
- Extra-long slip-lock design helps provide secure installation.
- 8 low-gloss colors.
- .039" thickness.
- 1.6 inches of net-free air per square feet - invisibly vented.

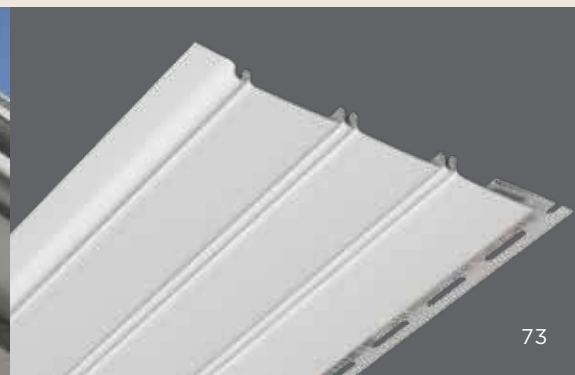

Ironmax™ Double 5"

Vinyl Soffit & Vertical Siding

- Solid and fully vented styles.
- Extra-thick .046" construction for optimum strength and flat face appearance.
- Designed for vertical siding, porch ceiling and soffit applications.
- Unique post-formed lock design helps ensure secure installation.
- 9 low-gloss woodgrain colors (Sable Brown for soffit applications only).
- 6.4 inches of net-free air per sq. ft.- fully vented.

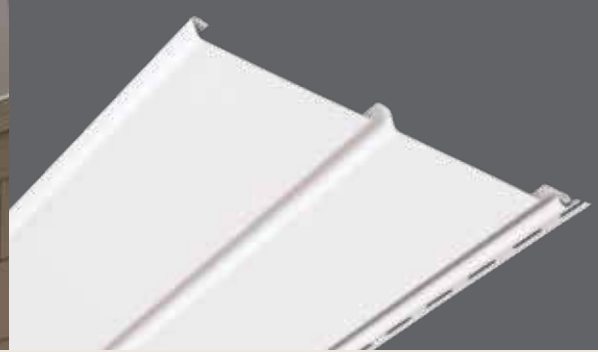

Universal Triple 4"

Vinyl Soffit & Vertical Siding

- Solid, fully vented and center vented styles. (Dimensions shown are nominal).
- Designed for vertical siding, porch ceiling and soffit applications.
- Matte finish.
- Post-formed lock design helps provide secure installation.
- 24 low-gloss colors (center vented: Colonial White and Snow only).
- .040" thickness.
- 5.9" of net-free air per sq.ft. - fully vented.
- 2 inches of net-free air per sq. ft. - center vented.

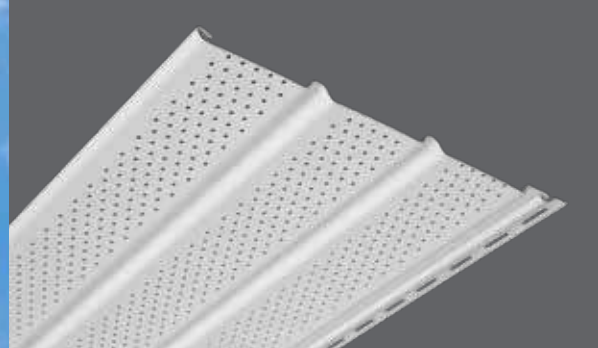

Universal Double 5"

Vinyl Soffit

- Solid and fully vented styles (soffit use only).
- Designed for soffit applications.
- Woodgrain finish.
- 8 low-gloss colors.
- .040" thickness.
- RigidForm technology provides strengthened nail hem for rigidity to perform under high wind conditions.
- 6.4 inches of net-free air per sq.ft. - fully vented.

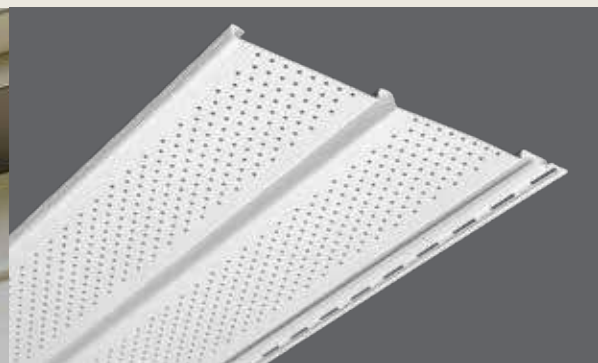



Ironmax Double 5" in Colonial White.

	D5 Ironmax	T4 Universal	D5 Universal	T4 Value	D5 Value
Black** <i>soffit use only</i>		●			
Musket Brown** <i>soffit use only</i>		●	●		
Brownstone		●			
Autumn Red		●			
Slate		●			
Espresso		●			
Sable Brown	●	●			
Forest		●			
Pacific Blue		●			
Flagstone		●			
Charcoal Gray		●			
Castle Stone		●			
Granite Gray	●	●			
Sterling Gray	●	●	●		
Oxford Blue		●			
Cypress		●			
Herringbone		●	●		
Sandstone Beige	●	●	●	●	
Desert Tan	●	●	●	●	
Natural Clay	●	●	●	●	
Savannah Wicker	●	●	●	●	
Heritage Cream		●			
Snow	●	●		●	
Colonial White	●	●	●	●	●

** Premium Colors

Value Triple 4" & Double 5" Vinyl Soffit

- Solid, fully vented and center vented styles.
- For use in new construction and remodeling.
- Post-formed lock design helps provide secure installation.
- Triple 4: 6 low-gloss colors (center vented: Colonial White only) (Dimensions shown are nominal).
- Double 5: 1 low-gloss color.

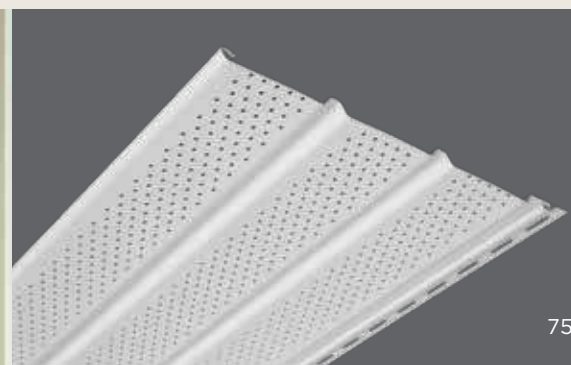

Triple 4"

Aluminum Soffit

- Solid, center vented and fully vented styles.
- Designed for soffit applications.
- 0.016" & 0.019" thickness options available.
- 4.4 inches of net-free air flow per sq.ft - fully vented.
- 1.47 inches of net-free air flow per sq.ft - center vented.

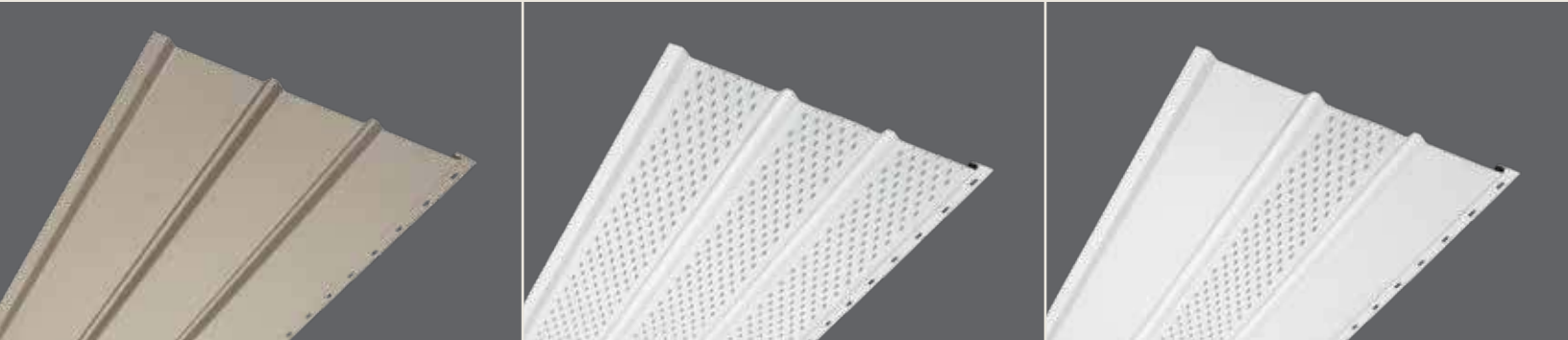

Quad 4"

Aluminum Soffit

- Solid, center vented and fully vented styles.
- Designed for soffit applications.
- 0.016" & 0.019" thickness options available.
- 11.5 inches of net-free air flow per sq.ft - fully vented.
- 5.75 inches of net-free air flow per sq.ft. center vented.

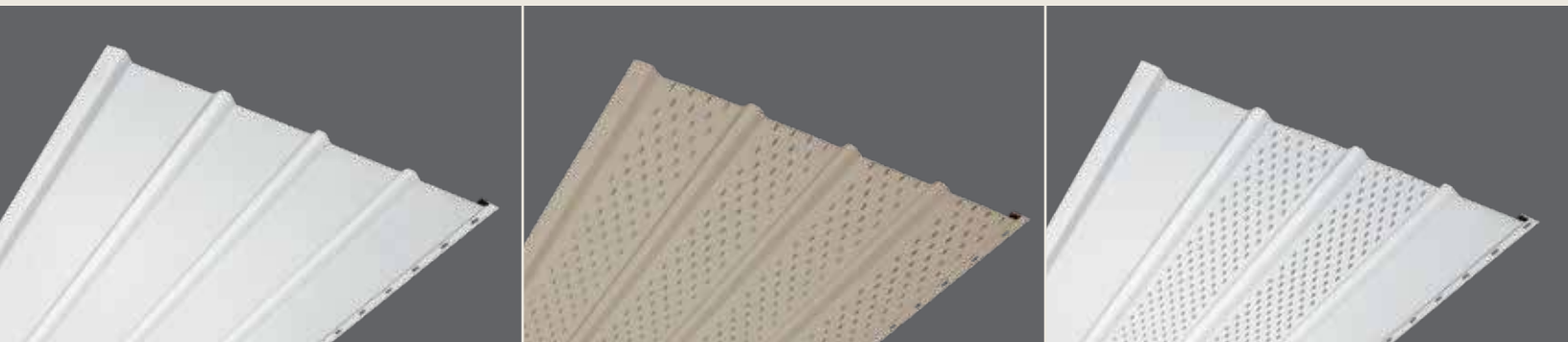

	T4	Q4	
Black LG	●	●	
Musket Brown	●	●	
Natural Clay	●	●	
Wolf White	●	●	
Colonial White	●	●	

Black LG



Musket Brown



Natural Clay



Wolf White



Colonial White



Aluminum Accessories

New aluminum accessories include:
Trim Coil, 3/8" J-Channel, 1/2" J-Channel,
9/16" F-Channel, 3/8" F-Channel, 6" Fascia,
8" Fascia, 1-1/2" Drip Edge and 2" Drip Edge.

Note: Trim Coil available in additional colors. Reference
Product Catalog 04-08-30-US-EN for more information.



Vinyl Carpentry®

Decorative Trim



T5" Straight Edge Sawmill
Offset Mitered Cornerpost



Cedar Impressions
Double 9" Staggered
Rough-Split Shakes
and Board & Batten
Single 8" Rough Cedar



J-Channel



Crown Molding
with 3-1/2" Lineals

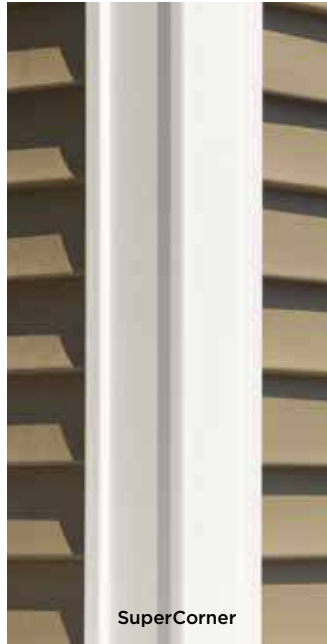

SuperCorner



Federal
Corner
created with
a 5" Lineal
and a 3-1/2"
Lineal

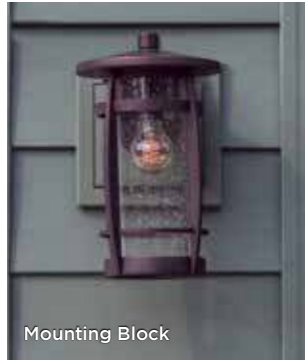

Mounting Block



Cedar Impressions Single 6-1/3"
Perfection Octagon in Autumn Red



Vinyl Carpentry®

Vinyl Carpentry trim offers you a wide array of decorative design possibilities to accent your home's exterior. Replicate the look of real wood with a wonderful assortment of styles and colors – and they never need painting.

- Designed to add distinction to windows, doors, corners, gables and frieze boards.
- Authentic painted wood look.
- New construction and remodeling installation flexibility.
- Wide variety of colors to coordinate with siding.
- Color-clear-through construction means scratches won't show.
- Virtually maintenance free, never needs painting.

Create the look of true wood craftsmanship with a complete line of decorative accents and trim pieces for both new construction and remodeling.

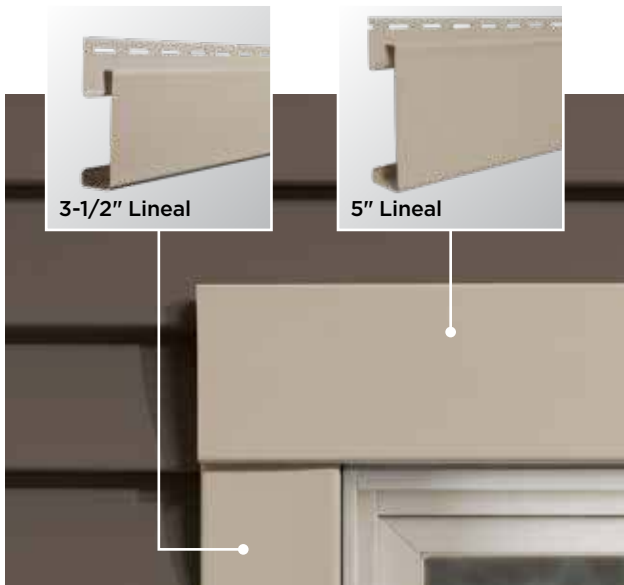

Window & Door Trim

- Crown Molding
- J-Channels
- Lineals



Corner Systems

- Outside Corner Posts
- Insulated Corner Posts
- Inside Corner Posts
- Mitered Corner Posts
- SuperCorners™
- Bay Window Corner Posts



Accents

- Cedar Impressions®
- Board & Batten
- Northwoods®



Wall & Soffit Transitions

- Cornice Molding
- Finish Board
- Band Board
- Double Channel Lineal
- H-Bars
- Lineals

Restoration Millwork®

Exterior Trim

The Ultimate Finish!

- Superior quality and excellent dimensional accuracy.
- Low-maintenance and long-lasting UV-resistant material.
- Natural white and ready to install.
- Can be painted* to complement exterior colors.
- Cuts and mills with traditional woodworking tools.
- Class A (Class 1) Flame Spread Classification.
- Meets ICC and CCMC code requirements.
- Made in U.S.A.
- Contains recycled content.
- 25-year limited warranty.

*See Installation Guidelines 17-03-1600-US-EN for painting instructions.



J-Pockets and Cut-Outs

Restoration Millwork trimboards with built-in J-pocket eases installation of corner trim and the cut-out allows the trimboard to lie flush with the siding around windows and doors with built-in nail flanges.



InvisiPro+ Casing

InvisiPro+ provides an attractive, easy-to-install alternative to traditional face nailing. Trimboards feature a hidden nail hem integrated into the J-pocket to conceal fasteners. The end result is a nail-free face with no holes left to fill.



One-Piece Corner

One-piece corner components add style and beauty. Corners are available in natural white, and like all Restoration Millwork components, can be painted to match or coordinate with other exterior elements.

Skirtboard with DualStart® Design

Engineered with DualStart Design (patent-pending) cuts installation time while providing the 6 in. ground clearance required by U.S. building codes for fiber cement siding.



Sheets

Available in a full selection of custom and standard sizes and shapes, sheets can be used to create distinctive, one-of-a-kind exterior elements that are as beautiful as they are durable.

Specialty Profiles



#45, 47, 49 Crown

Brickmould

Paint Grade
Brickmould

J-Channel
Brickmould

Back Band

RB3 Casing

356 Casing

Sill



Adjustable
Back Band

Base Cap

Drip Cap

Water Table

Shingle Mould

Bed Mould

Inside Corners

Rake

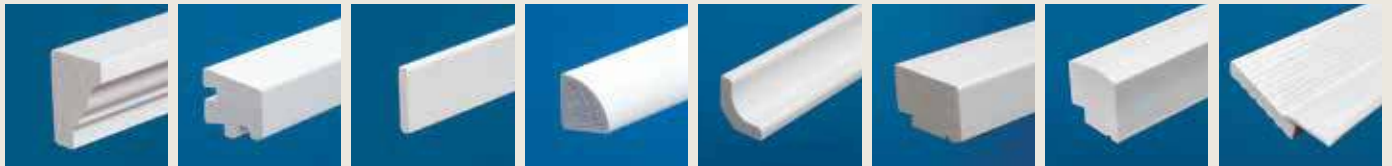

Rams Crown

Sill Nose

Lattice

Quarter Round

Cove Moulding

Historic Sill

New England Sill

Garage Door Trim

Column Wraps

**Slides On, Swings Closed
for Fast, Easy Installation**

A three-sided wrap with a swinging door on the fourth side, Column Wraps are pre-cut and pre-mitered, to slide around existing wood load-bearing 4 in. x 4 in. or 6 in. x 6 in. porch posts.

Simple and versatile, with 2 column sizes: 8 in. x 8 in. and 10 in. x 10 in. square.



Estate cap/base

Classic cap/base

Beadboard with TightLap™

Whether you choose 2TL or 3TL, Beadboard with TightLap is designed to have a larger nailing area with the security of tongue and groove.



WP4 with TightLap™
and Nickel Gap (on reverse)



Beadboard with
TightLap™



Beadboard 2TL and 3TL
are Reversible

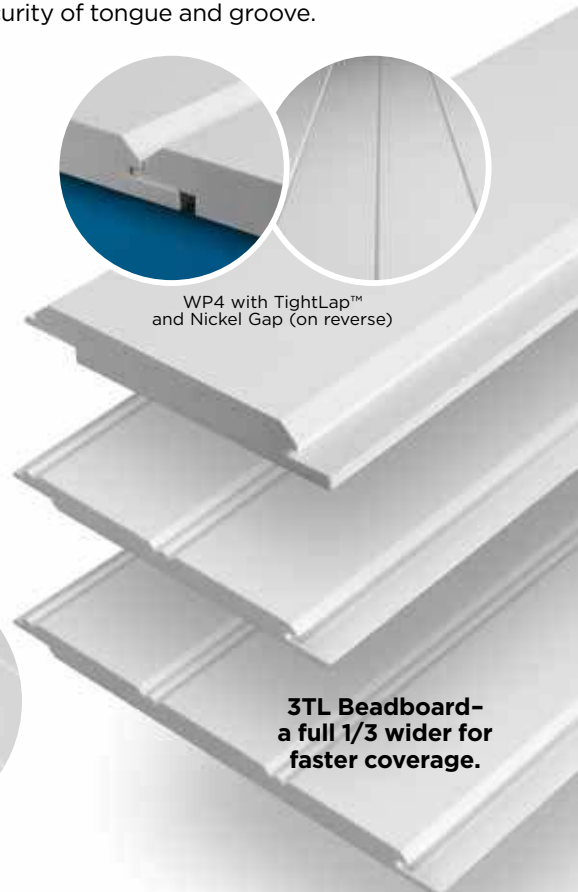

**3TL Beadboard—
a full 1/3 wider for
faster coverage.**

Fascia Trimboard

Fascia trimboard with built-in return leg is designed to work with a wide range of soffit materials. Available in TrueTexture™ and smooth finish.



Finishing Touches



J-Channel



3-1/3" Cornerpost



Restoration Millwork trimboard*



3-1/2" Lineal with miter cut corners



3-1/3" Cornerpost

Good

Better



Siding: CedarBoards™ Single 7" Clapboard in Sterling Gray.
 Trim: Vinyl Carpentry® in Colonial White and Sterling Gray.
 Roofing: Landmark® Shingles in Georgetown Gray.



Siding: CedarBoards Single 7" Clapboard and Board & Batten Single 8" in Sterling Gray with Cedar Impressions Double 7" Straight Edge Perfection Shingles in Charcoal Gray.
 Trim: Vinyl Carpentry® & Restoration Millwork® in Colonial White.
 Roofing: Landmark Shingles in Georgetown Gray.

Details Create the Personality

Here are just a few of many ideas for finishing gables, windows, corners, columns, porches and more. With CertainTeed exterior products, there are no limits to the unique personality you can create. And by adding just the right balance of details, you are improving the curb appeal and value of your home.



Restoration Millwork Classic Column Wraps



STONEfaçade® Corners



Vinyl Carpentry Cornice Molding and Restoration Millwork Rake Profile



Restoration Millwork Trimboard with Rams Crown



Restoration Millwork One-Piece Corner

Best



Siding: CedarBoards Single 7" Clapboard in Sterling Gray and Cedar Impressions Double 7" Straight Edge Perfection Shingles in Charcoal Gray with STONEfaçade in Adirondack Snowfall.

Trim: Vinyl Carpentry® & Restoration Millwork® in Colonial White.

Roofing: Landmark Shingles in Georgetown Gray.

CertaWrap™

Weather Resistant Barrier

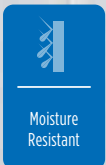

CertaWrap Accessories

CertaTape™



available in 1-7/8" x 165'

For maximum effectiveness, it's critical to finish your CertaWrap installation with tight sealing methods. CertaWrap accessories offer everything needed to get the job done right. Use them to seal window and door openings, cracks, seams and penetrations prior to applying exterior cladding.

CertaWrap Weather Resistant Barriers, in premium or standard grade, provide an added layer of protection against air and moisture damage. It's part of the complete CertainTeed Weather Deterrence Wall System.

- The best defense against mold, mildew and water damage.
- Superior air holdout for better energy efficiency.
- Optimal Permeance Rating of **11.7 (Premium)**.
Optimal Permeance Rating of **12-15 (Standard)**.
- Outstanding UV performance.
- Excellent surfactant resistance.
- Double-strength tear resistance.
- Easy handling and installation with STUDfinder™.
- Class 1(A) fire rating.
- Lifetime limited warranty.
- Available co-branded with your logo!

Moisture Technology, inside and out

Beauty is more than skin deep. That's especially true when it comes to building or improving a home. Moisture protection, energy efficiency and long-term performance are just as important as aesthetics. The CertainTeed Weather Deterrence Wall System delivers those advantages. As a key component in the system, CertaWrap Weather Resistant Barrier provides protection from the elements, and helps assure long-term satisfaction.

The CertainTeed Weather Deterrence System

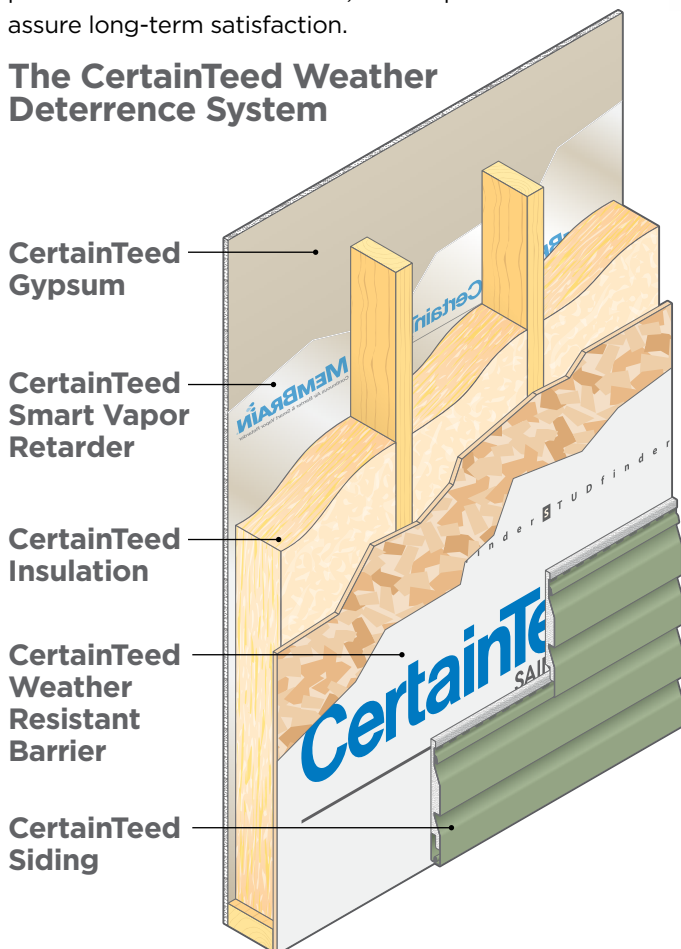

CertaWrap Premium Weather Resistant Barrier Performance

Superior Breathability, Water Resistance and Vapor Transmission

Mold, mildew and water damage are a home's worst enemies. An effective weather barrier system defends against these problems by resisting moisture penetration and air infiltration while allowing water vapor to dissipate. CertainTeed CertaWrap offers the industry's best combination of all of these properties, helping you defend against moisture and the elements during construction, and preventing moisture buildup - from inside and outside the home - after cladding is applied.

CertaWrap is available in the following roll dimensions:

	Premium	Standard
	3' x 100'	9' x 100'
	3' x 165'	
	4.5' x 200'	
	5' x 200'	
	9' x 100'	
	9' x 150'	

CertaWrap Standard Housewrap

CertaWrap Standard Housewrap is a coated poly woven fabric for use in housewrap applications that controls airflow through the wall and protects against outside water from penetrating the exterior of a home. It is engineered to resist water while allowing water vapor to pass through and is stabilized to resist degradation.

CertainTeed products are designed to work together and complement each other in color and style to give any home a beautiful finished look.



VINYL SIDING



POLYMER SHAKES & SHINGLES



INSULATED SIDING



METAL SIDING



ROOFING AND VENTILATION



STONE



HOUSEWRAP



COMPOSITE SIDING



VINYL CARPENTRY® TRIM



PVC EXTERIOR TRIM & BEADBOARD



VINYL & METAL SOFFIT



CertainTeed

Ceilings • Gypsum • Insulation • Roofing • Siding • Trim

20 Moores Road, Malvern, PA 19355 | 800-233-8990 | certainteed.com

©01/25 CertainTeed, Printed in the USA, Code No. 04-00-20-NA-EN